BuzziFalls

Product Specification Sheet

Discover all insights on BuzziFalls.
Acoustical room dividers offering you a
variety of patterns, sizes and colors to
organize your space.







www.buzzi.space

A playful solution to regulate sounds

To divide a space and create some privacy, the BuzziFalls are a new playful variation in our acoustic solutions gamma. These strips are made out of BuzziFelt with cut out shapes in various patterns, for example falling leaves. A playful solution to regulate sounds and create smaller areas in big spaces.

Design by Sas Adriaenssens

General

-  Pattern: Alhambra, Birch, Dots, Grid, Leaves, Orient, Palms, Parrots, Pebbles, Plain, Rain, Royal, Tropics
Skylines: Atlanta, Chicago, London, Paris, New York, San Francisco (set of 3 panels)
Monocolor | Bicolor
-  2 layers of BuzziFelt
Profile metal powdercoated black | RAL 9005 matte or metal powdercoated White | RAL 9010 matte
Pendant black steel cable for black profile | silver steel cable for white profile
-  Pattern: W 80 cm, H 220 or 250 cm, D 1 cm
W 31.50", H 86.61 or 98.42", D 0.40"
Skylines: W 80 cm, H 100, 150, 220 or 250 cm, D 1 cm
W 31.50", H 39.37, 59.05, 86.61 or 98.42", D 0.40"
-  BuzziFall wall | Ceiling mounted or BuzziFall Suspended
Cable L 2 or 5 m, Ø 1,5 mm
L 78.74 or 196.85", Ø 0.06"
Possibility to connect several falls
Rail (1 | 2 | 3 falls in 1 rail)
Extra rail for extension

Content

Fabrics	3
Patterns	3
Fixing systems	8
Option Rail	12
Dimensions	13
Acoustics	15

Fabrics

Felt

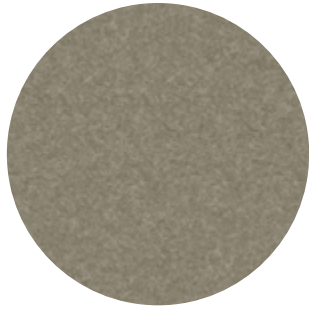

Composition 100% Recycled P.E.T. Felt, latex backing
Weight 1.000 g/m2 | 29.49 oz/yd2
Abrasion resistance >7.000 Martindale
Flammability EU: EN 13501.1 + A1/2009 Class B-s1,d0
 USA: ASTM E84 Class A certified
Fastness to light USA 5



Patterns

Alhambra

250 cm 98.42" 3,1 kg 6.83 lbs
 220 cm 86.61" 2,8 kg 6.17 lbs

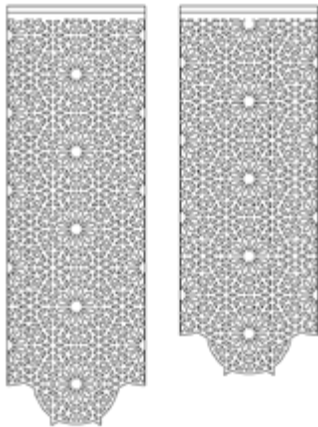

Birch

250 cm 98.42" 2,6 kg 5.70 lbs



Dots

250 cm 8.42" 4,6 kg 10.14 lbs
 220 cm 86.61" 4 kg 8.82 lbs

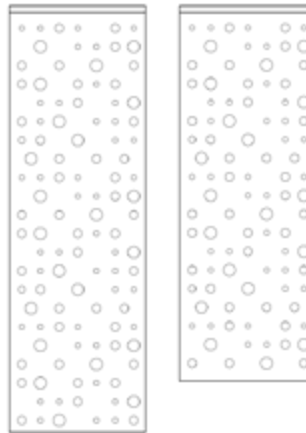

Grid

250 cm 8.42" 3 kg 6.61 lbs
 220 cm 86.61" 2,6 kg 5.73 lbs

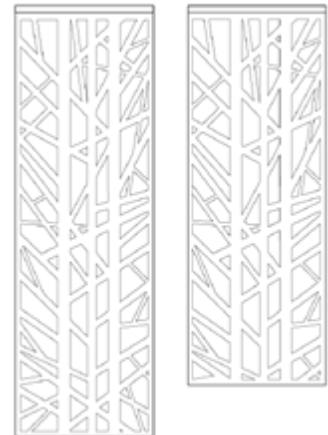

Leaves

250 cm 98.42" 3,1 kg 6.83 lbs
 220 cm 86.61" 2,8 kg 6.17 lbs

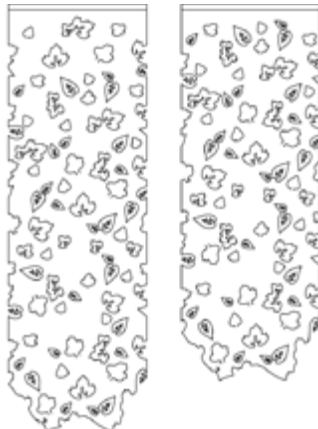

Orient

250 cm 8.42" 3,7 kg 8.16 lbs



Palms

250 cm 8.42" 4,3 kg 9.48 lbs



Parrots

250 cm 8.42" 3,6 kg 7.94 lbs
 220 cm 86.61" 3,2 kg 7.05 lbs



Pebbles

250 cm 98.42" 2 kg 4.41 lbs
220 cm 86.61" 1.8 kg 3.97 lbs

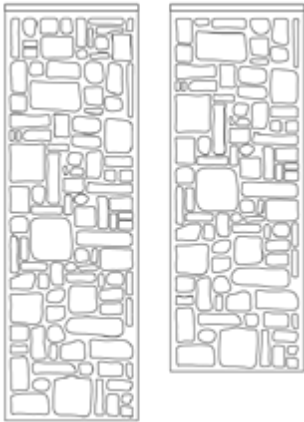

Plain

250 cm 98.42" 4,5 kg 9.92 lbs



Rain

250 cm 98.42" 3,9 kg 8.60 lbs
220 cm 86.61" 3,4 kg 7.50 lbs

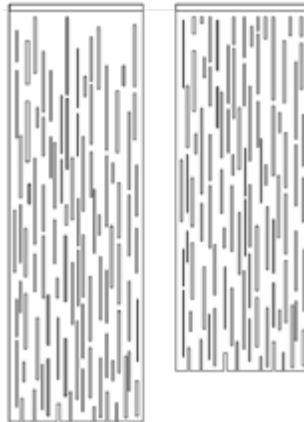

Royal

250 cm 98.42" 3,6 kg 8.00 lbs
220 cm 86.61" 3,2 kg 7.05 lbs

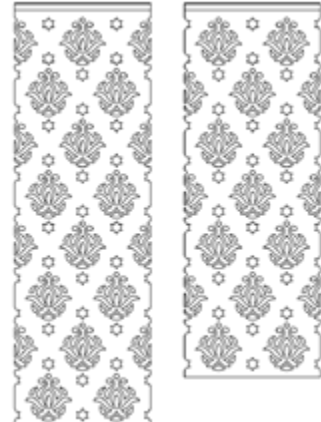

Tropics

250 cm 98.42" 3,1 kg 6.83 lbs
220 cm 86.61" 2,7 kg 5.95 lbs

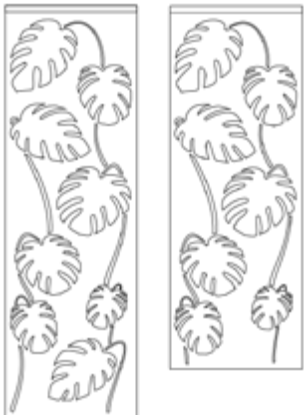

Skylines

New York

250 cm 98.42"

4,2 kg 9.26 lbs 4,0 kg 8.80 lbs 4,0 kg 8.80 lbs

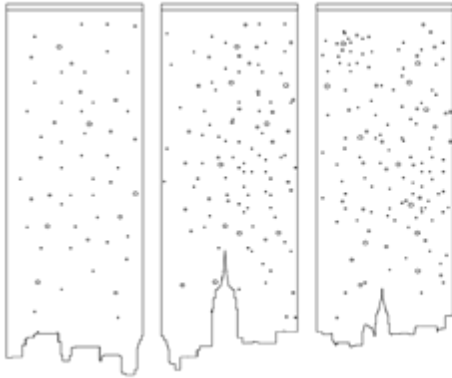

150 cm 59.05"

2,5 kg 5.59 lbs 2,3 kg 5.15 lbs 2,3 kg 5.15 lbs

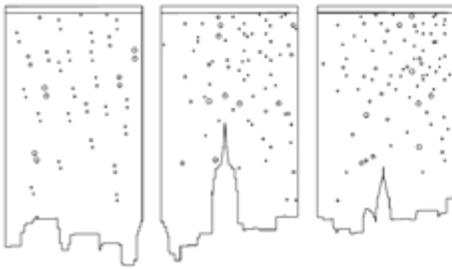

220 cm 86.61"

3,7 kg 8.1 lbs 3,5 kg 7.71 lbs 3,5 kg 7.71 lbs

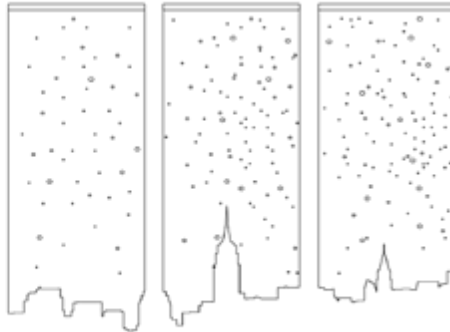

100 cm 39.37"

1,7 kg 3.76 lbs 1,5kg 3.32 lbs 1,5 kg 3.32 lbs



Chicago

250 cm 98.42"

4,2 kg 9.26 lbs 3,9 kg 8.60 lbs 4,1 kg 9.03 lbs

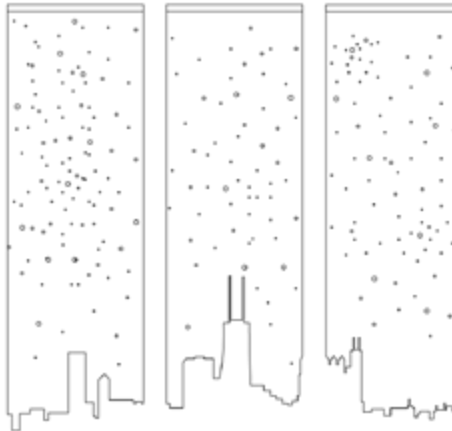

150 cm 59.05"

2,5 kg 5,59 lbs 2,2 kg 4,93 lbs 2,4 kg 5,37 lbs

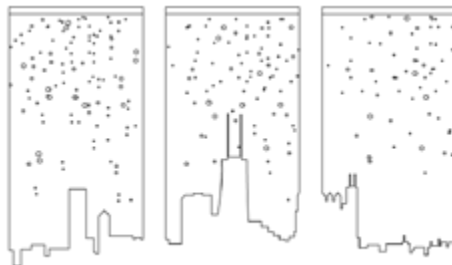

220 cm 86.61"

3,9 kg 8,60 lbs 3,5 kg 7.71 lbs 3,6 kg 8.16 lbs

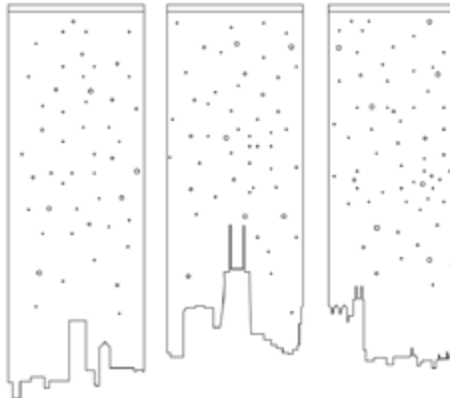

100 cm 39.37"

1,7 kg 3.76 lbs 1,4 kg 3.10 lbs 1,6 kg 3,54 lbs

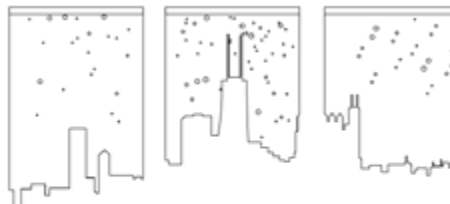

Atlanta

250 cm 98.42"
4,3 kg 9.47 lbs 4,1 kg 9.03 lbs 4,0 kg 8.81lbs

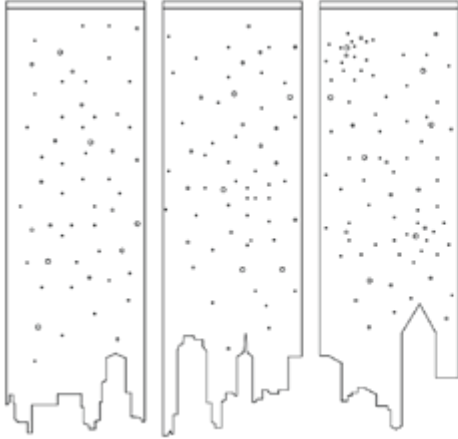

150 cm 59.05"
2,6 kg 5.82 lbs 2,5 kg 5.59 lbs 2,4 kg 5.37 lbs

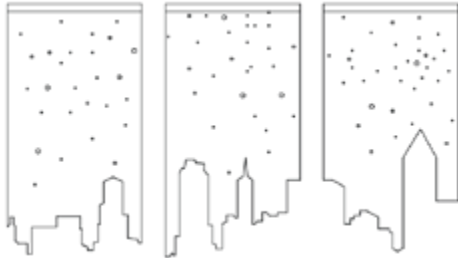

220 cm 86.61"
3,8 kg 8.37 lbs 3,6 kg 8.16 lbs 3,5 kg 7.71 lbs

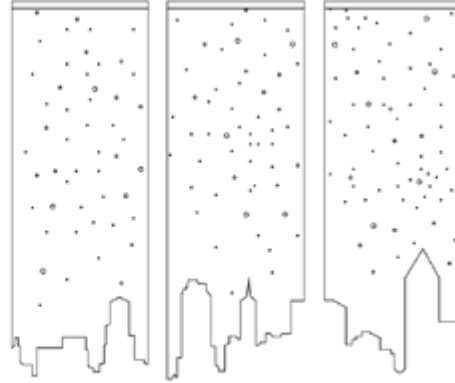

100 cm 39.37"
1,7 kg 3.76 lbs 1,6 kg 3.54 lbs 1,6 kg 3.54 lbs

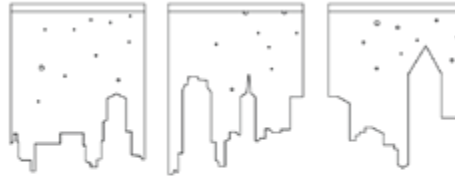

San Francisco

250 cm 98.42"
4,3 kg 9.47 lbs 4,2 kg 9.25 lbs 4 kg 8.81 lbs

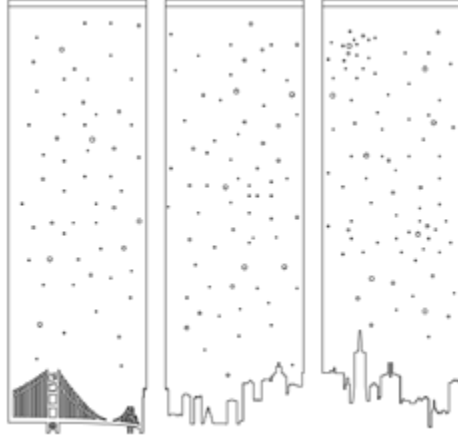

150 cm 59.05"
2,6 kg 5.82 lbs 2,5 kg 5.59 lbs 2,3 kg 5.15 lbs

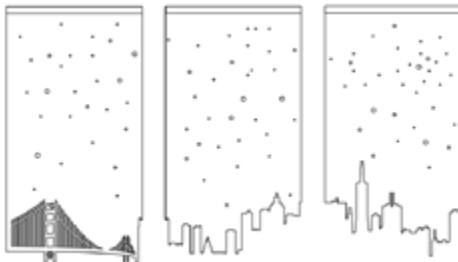

220 cm 86.61"
3,9 kg 8.59 lbs 3,7 kg 8.15 lbs 3,5kg 7.71 lbs

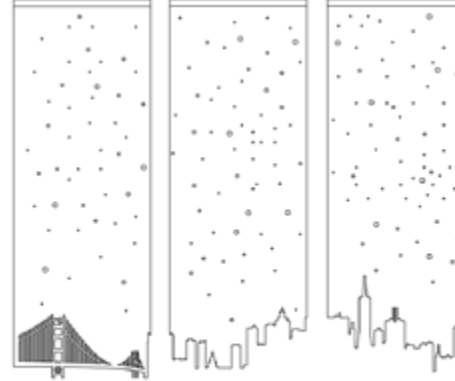

100 cm 39.37"
1,8 kg 3.99 lbs 1,7 kg 3.76 lbs 1,51 kg 3.32 lbs

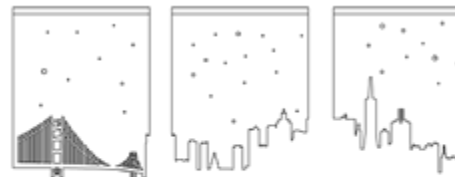

London

250 cm 98.42"

4,2 kg 9.25 lbs 4,2 kg 9.25 lbs 4,3 kg 9.47 lbs

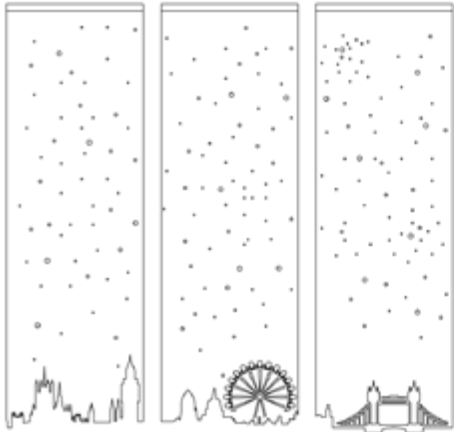

220 cm 86.61"

3,7 kg 8.15 lbs 3,7 kg 8.15 lbs 3,8 kg 8.37 lbs

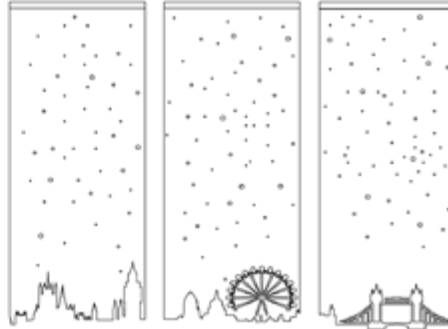

150 cm 59.05"

2,5 kg 5.59 lbs 2,5 kg 5.59 lbs 2,6 kg 5.82 lbs

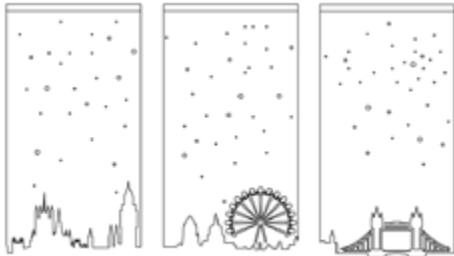

100 cm 39.37"

1,7 kg 3.76 lbs 1,7 kg 3.76 lbs 1,8 kg 3.99 lbs

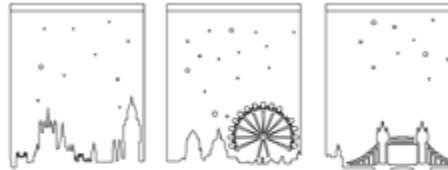

Paris

250 cm 98.42"

4,4 kg 9.70 lbs 4,2 kg 9.25 lbs 4,2 kg 9.25 lbs

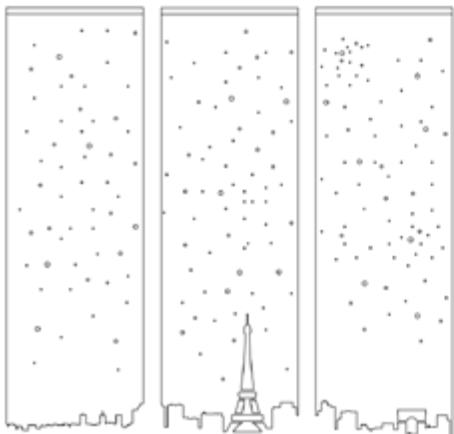

220 cm 86.61"

3,9 kg 8.59 lbs 3,8 kg 8.37 lbs 3,8 kg 8.37 lbs

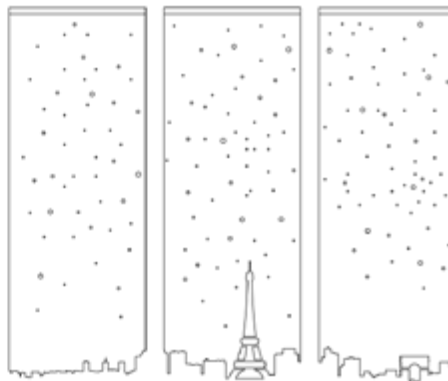

150 cm 59.05"

2,7 kg 6.04 lbs 2,5 kg 5.59 lbs 2,5 kg 5.59 lbs

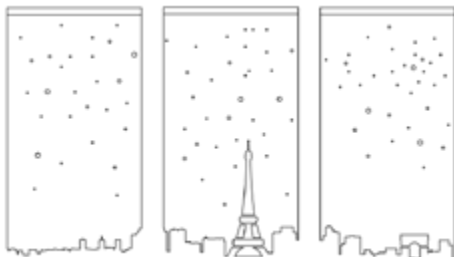

100 cm 39.37"

1,9 kg 4.21 lbs 1,7 kg 3.76 lbs 1,7 kg 3.76 lbs



Fixing Systems

BuzziFalls Suspended

BuzziFalls Suspended > 1

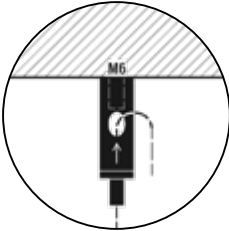
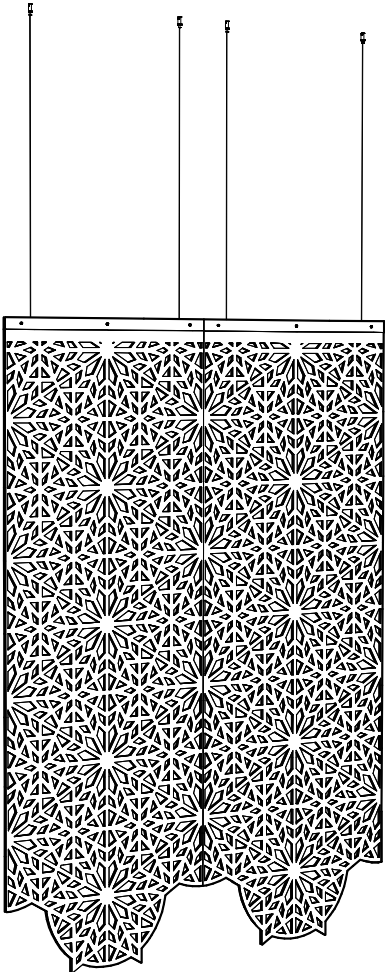
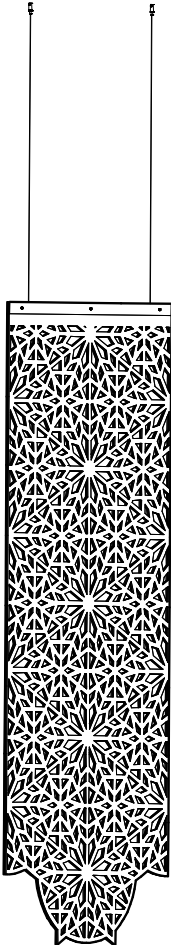

Profile black or white

2 cables per set, incl fastner
(stair bolts M6 not included)

Black or Silver colored cable
L 200 or 500 cm, Ø 1,5 mm
L 78.74" or 196.85", Ø 0.06"

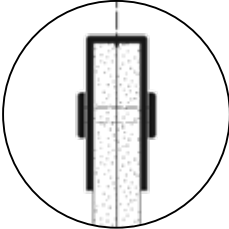

BuzziFalls Ceiling Mounted

BuzziFalls Ceiling Mounted > 1

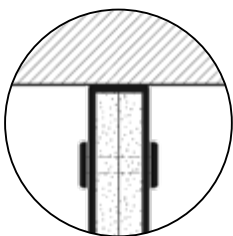
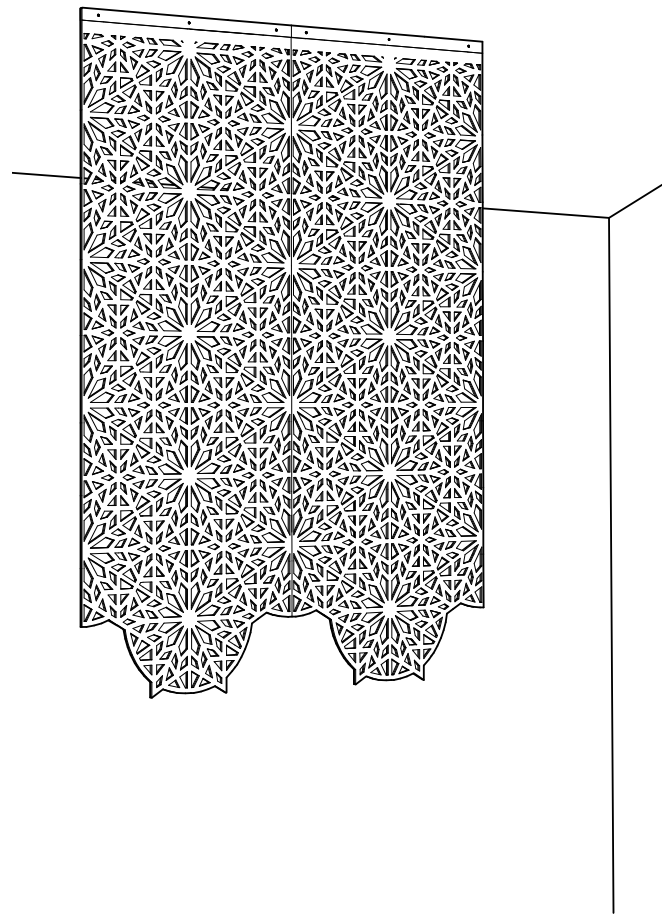
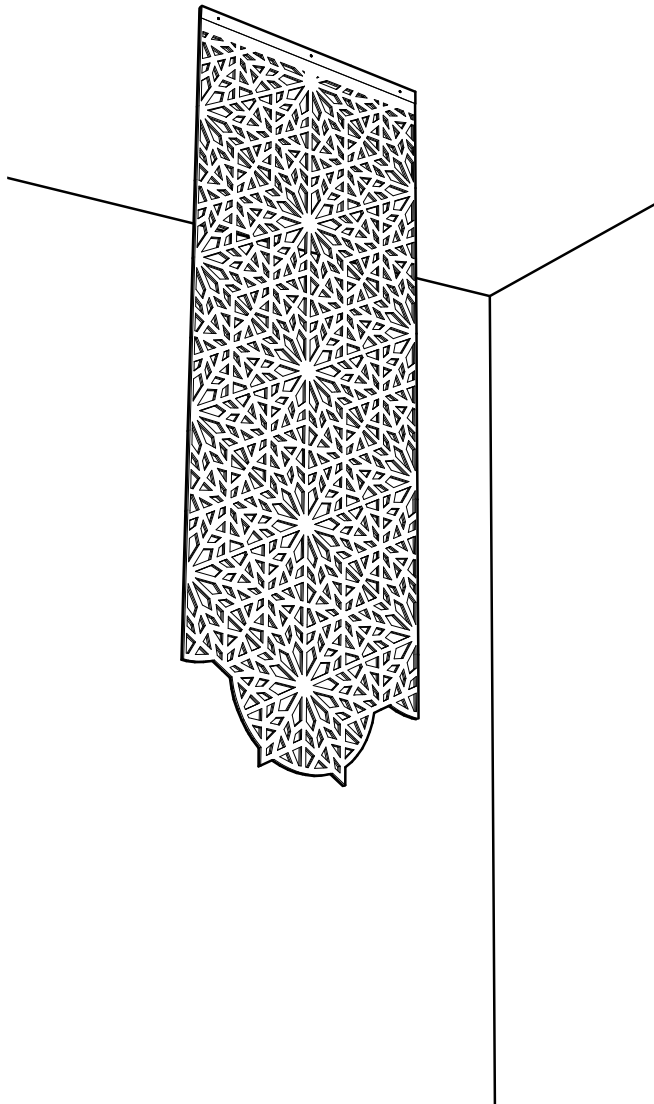

Profile black or white

BuzziFalls Mounted Wall

BuzziFalls Wall > 1

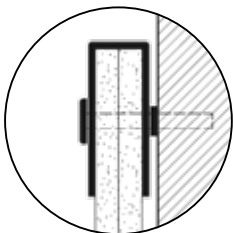
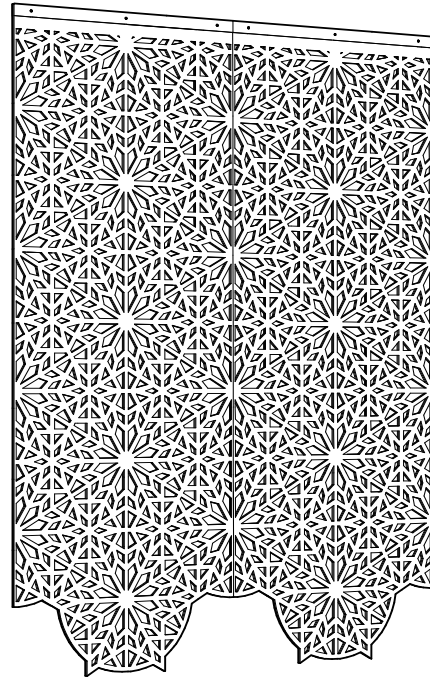
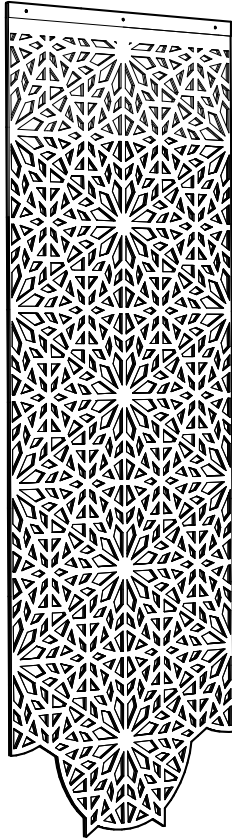

Profile black or white

3 screws 4x60 mm per set

3 cover caps per set, black or white, depending on colour of profile

6 distance holders: 3 x 3 mm and 3 x 7,5 mm per set

BuzziFalls Rail Suspended

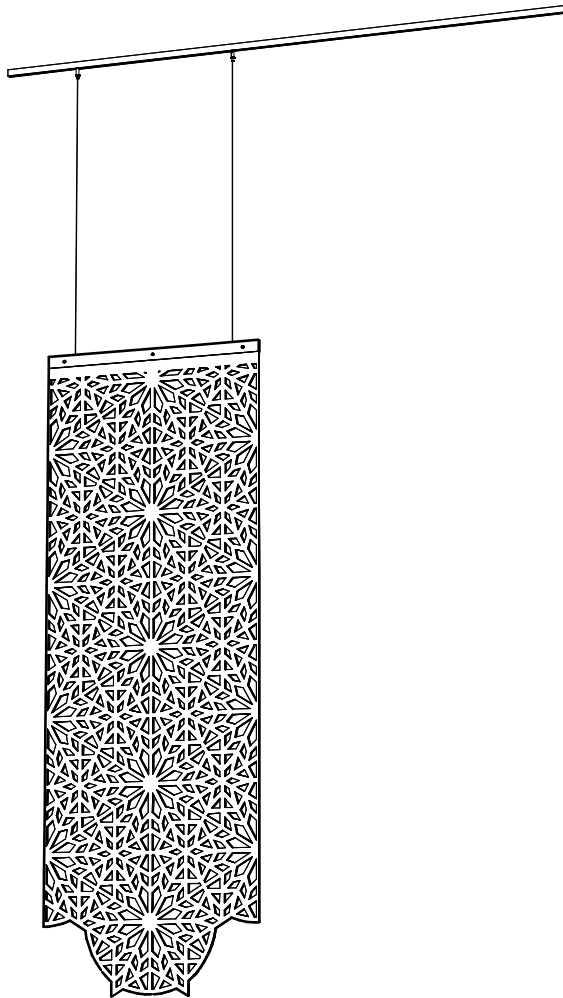

BuzziFalls Rail Mounted

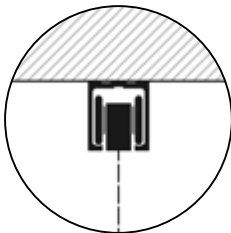
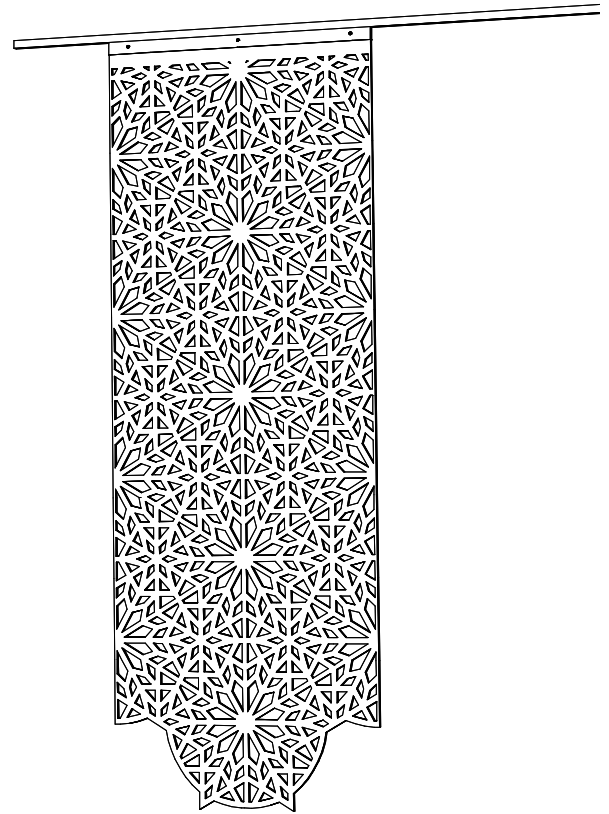

Rail black or white
L: 3,20 m | 125.98"

Profile black or white

Black or Silver colored cable
L 200 or 500 cm,
Ø 1,5 mm
L 78.74" or 196.85",
Ø 0.06"

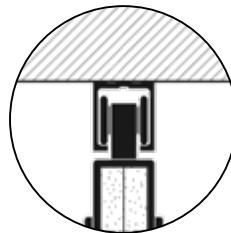
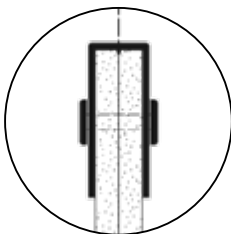

Rail black or white
L 3,20 m | 125.98"

Profile black or white

Option: Rail

The rail can be extended by buying a extra rail

BuzziFalls Rail Suspended

Profile black or white

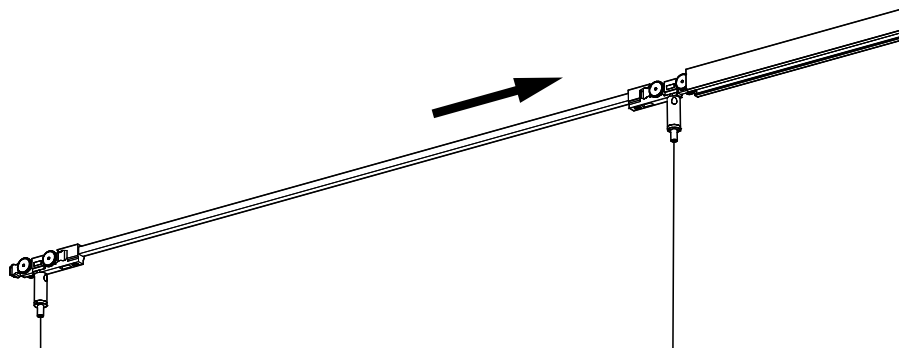

BuzziFalls Rail Mounted

Profile black or white

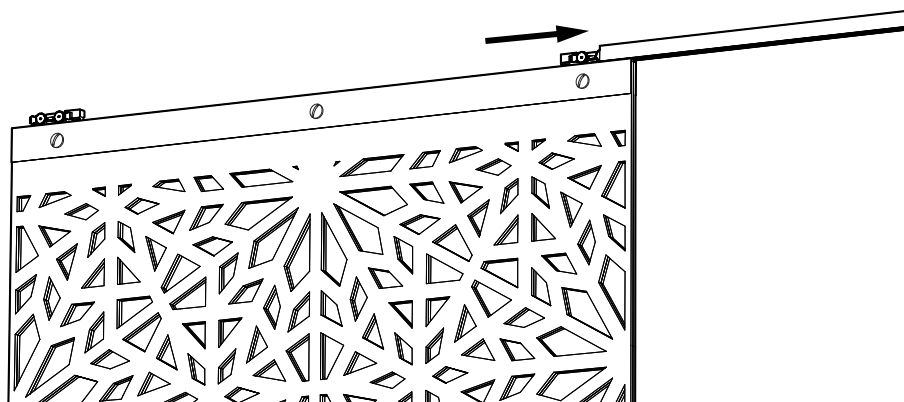

Rail

Black or white, L 3,20 m | 125.98".

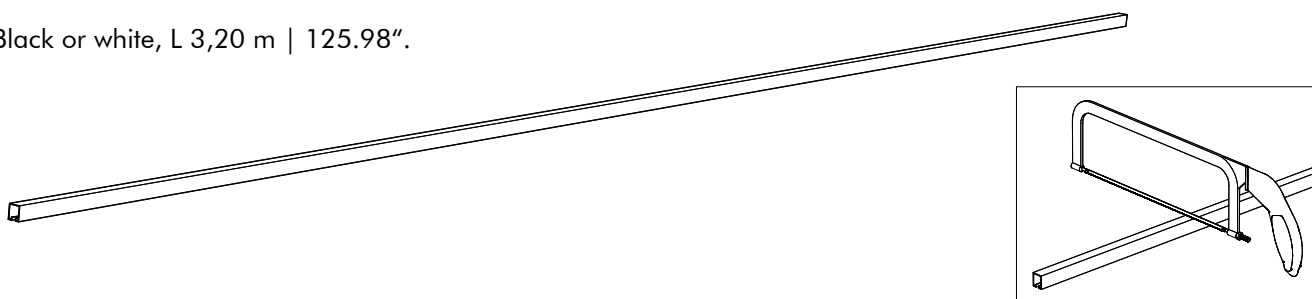

End cap

Stop end black or white included

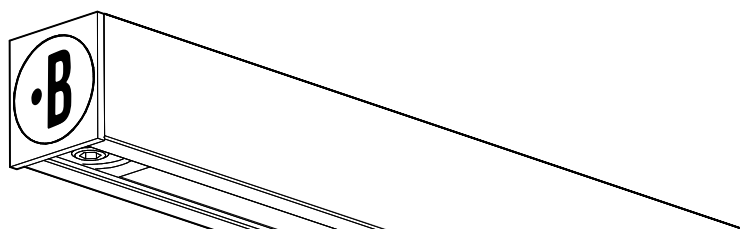

Dimensions

Falls Felt

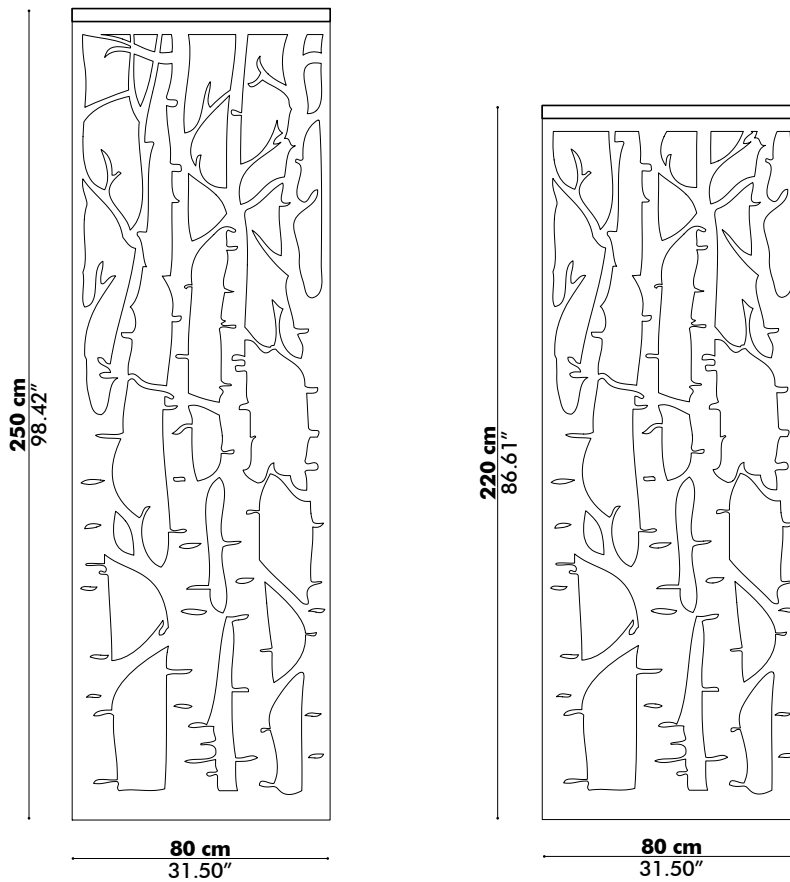

Metal Profile

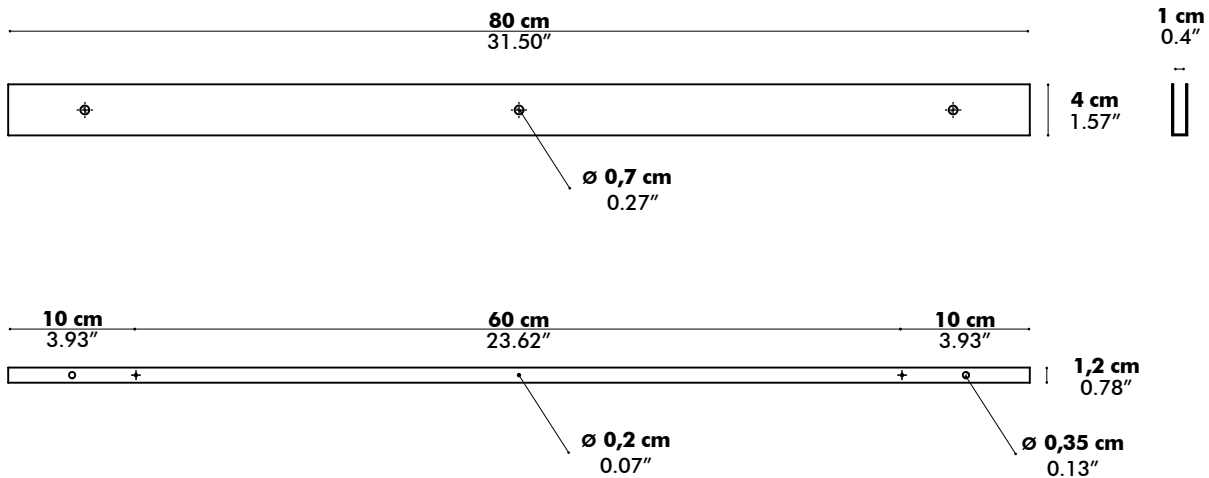

500 gr | 1.10 lbs

Alu Rail

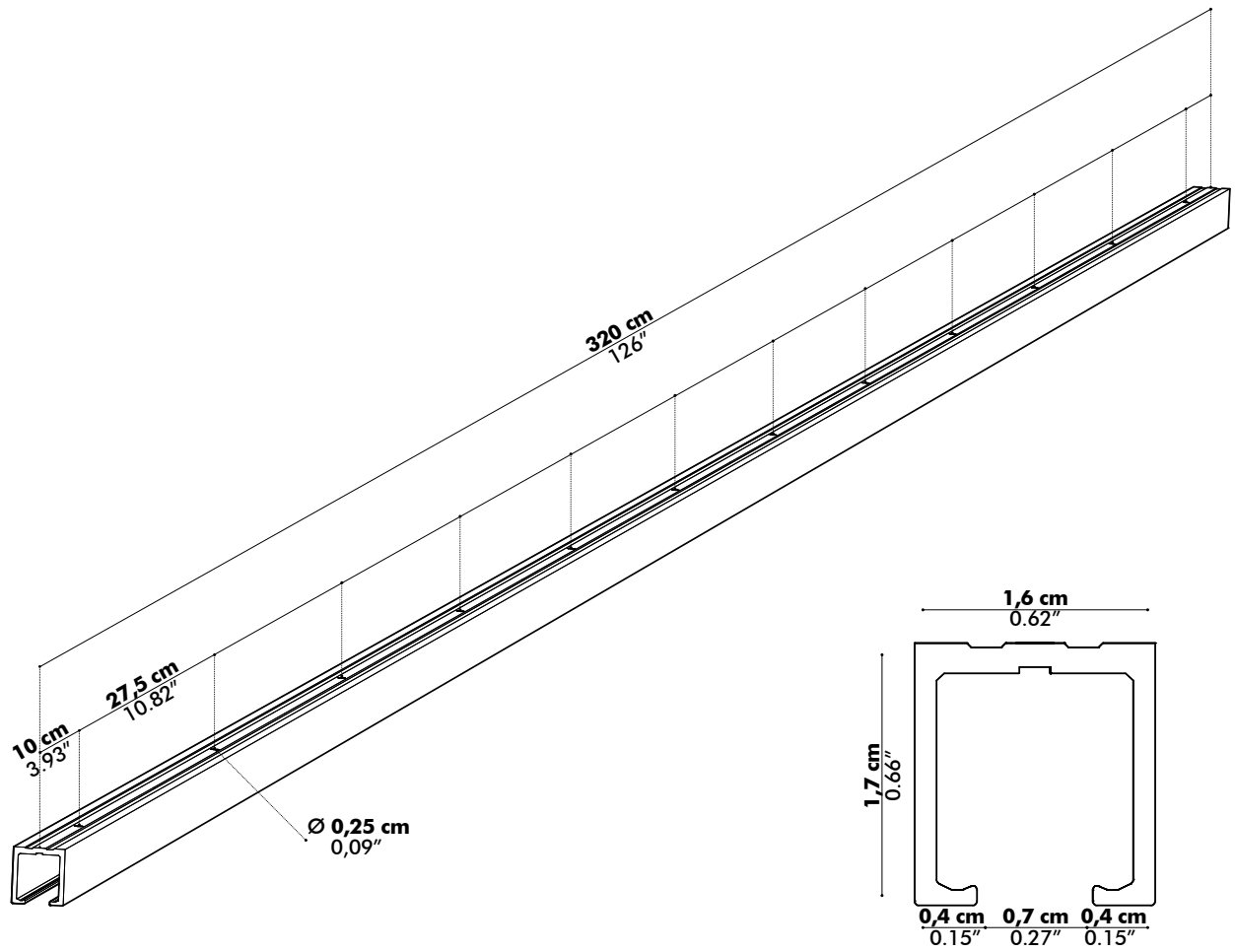

Acoustics

BuzziFalls Alhambra | Birch | Plain

Equivalent sound absorption area in m² per object

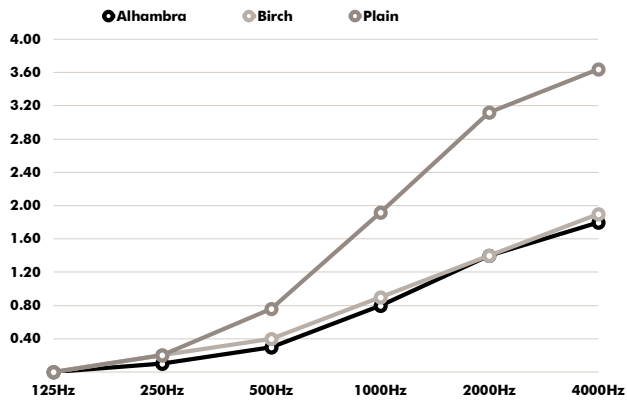

Hz	Alhambra Aeq/m ²	Birch Aeq/m ²	Plain Aeq/m ²
125	0.00	0.00	0.04
250	0.10	0.20	0.20
500	0.30	0.40	0.76
1000	0.80	0.90	1.92
2000	1.40	1.40	3.12
4000	1.80	1.90	3.64