

BOS  
1964  
BARCELONA

The executive  
furniture company

CONFERENCE BOOK  
*REUNIONES BOOK*

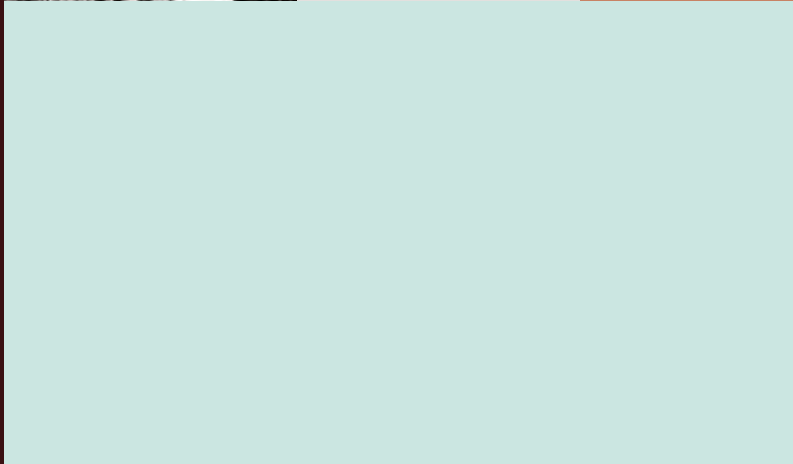

**WELCOME TO BOS1964**

**We are The Executive Furniture Company  
and provide beauty and luxury to the executive floor.**

*BIENVENIDO A BOS1964*

*Somos la empresa de mobiliario de dirección  
que integra diseño y calidad máxima en las áreas  
ejecutivas.*

## What we do Qué hacemos

We call ourselves The Executive Furniture Company since we are exclusively dedicated to the executive floor. Our products across our 3 areas of expertise are always created with a very high level of finishes. At BOS1964 we take pride in producing the best and most exclusive finishes in natural wood veneers, top Grain European cowhides and piano lacquer finishes. We are very flexible and will generally be able to accommodate any special requests in finishes.

*Nos llaman "la empresa de mobiliario de dirección" por nuestra dedicación en exclusiva a las distintas soluciones y necesidades de 3 grandes áreas ejecutivas: mesas de dirección, productos tapizados y mesas de juntas. BOS1964 ofrece una gama de acabados y materiales de máxima calidad en madera, piel, metal, lacas y barnices y una gran flexibilidad de adaptación a las necesidades requeridas en cada proyecto.*



- 2) **Upholstered items** with chairs and sofas for the executive office, conference room, VIP area or hotel lobby.
- 2) **Productos tapizados** sillones y sofás para despachos ejecutivos, salas de juntas, zonas VIP o el lobby de un hotel.

- 1) **Executive deskings** for the individual executive office with solutions for chairmen, CEO's, directors and managers.

- 1) **Mesas de dirección** creadas para los despachos de ejecutivos y consejeros delegados.



- 3) **Conference tables** with meeting solutions from a small meeting table for an executive office to a boardroom table with automated screens for a large corporation and available in any shape or size.

- 3) **Mesas de juntas** soluciones que van desde las pequeñas mesas de reunión hasta las grandes mesas de consejo integradas en espacios diversos con una gran variedad de opciones técnicas, informáticas y de sonido según necesidades.





Both have made it. All generations since then have considered their collections to be current and at the forefront in creating contemporary classics.

*Ambos lo han conseguido. Todas las generaciones desde esta fecha han considerado siempre actuales sus colecciones que han sido punteras desde los inicios y siguen en primera línea en la actualidad.*

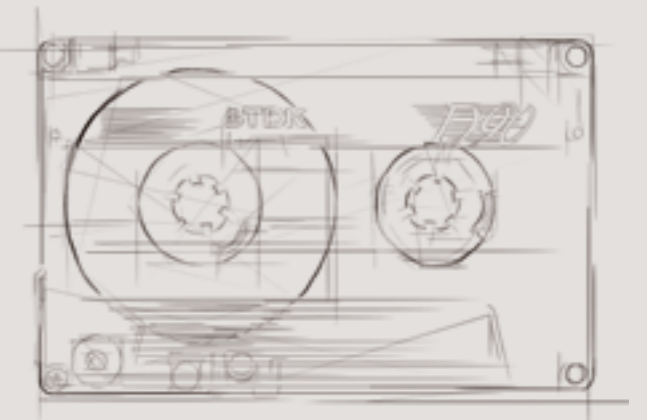
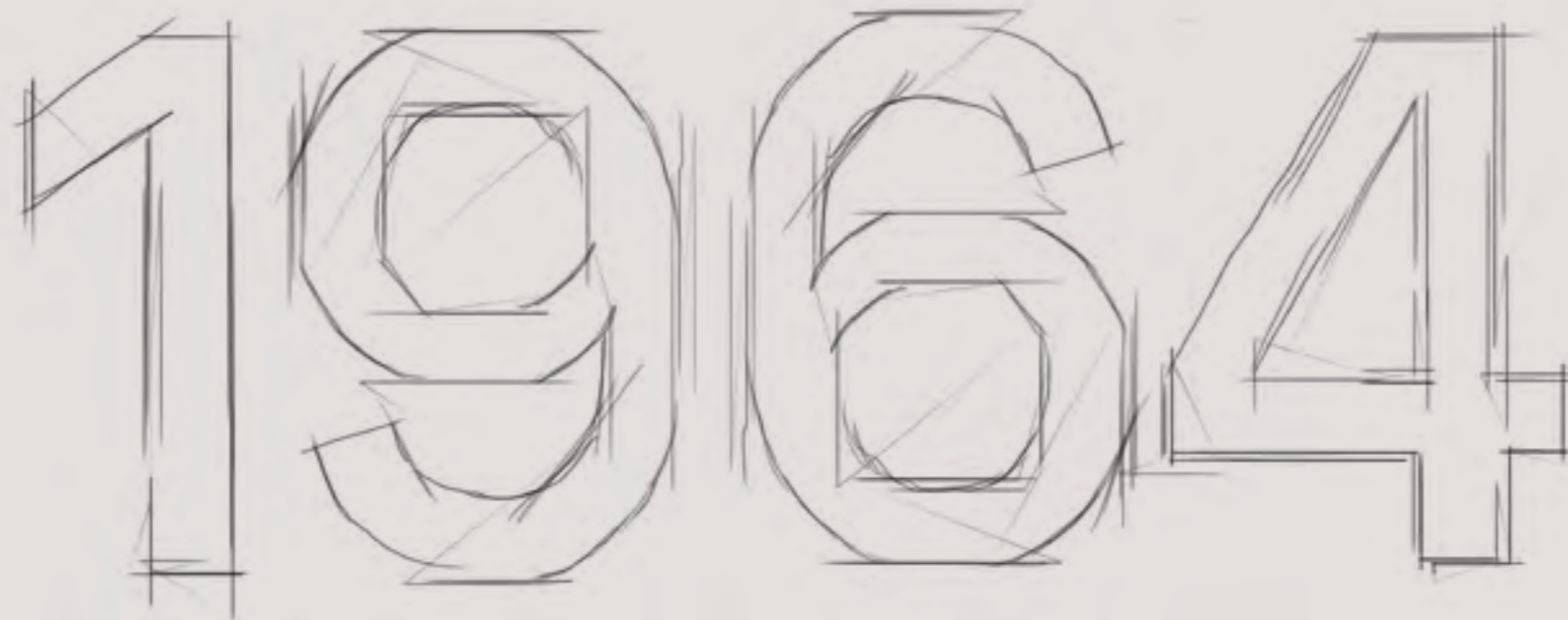

As the cassette revolutionized the world of music, making it possible to listen to your favorite artists anytime and anywhere, BOS1964 has revolutionized the world of top management furniture achieving status as the preferred choice globally.

*Como el casete revoluciona el mundo de la música permitiendo escuchar a tus preferidos en cualquier lugar y en cualquier momento BOS1964 ha revolucionado el mundo de mobiliario la alta dirección haciendo que sus productos sean los preferidos en todos los mercados internacionales.*

The Olympic spirit is the spirit of BOS1964. International above all. Collections for all countries with capacity to satisfy and combine very diverse aspects that are valid for all continents.

*El espíritu de una olimpiada es el espíritu de BOS1964. Internacionalidad por encima de todo. Colecciones para todos los países capaces de satisfacer y conjugar los aspectos más diversos válidos para cualquier continente.*

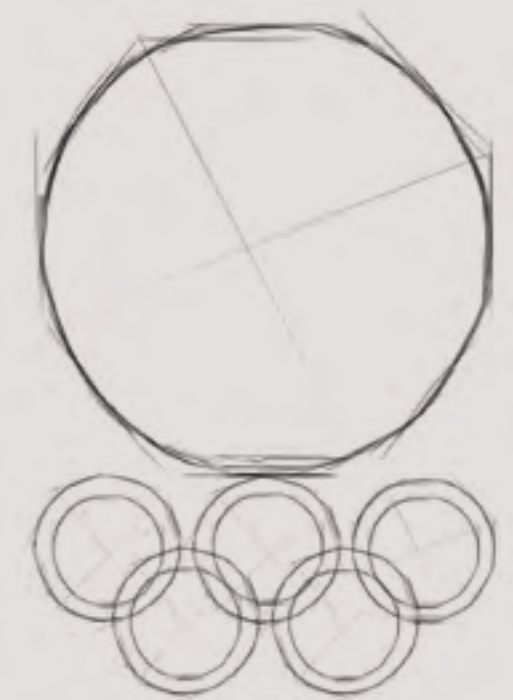

TOKYO 1964

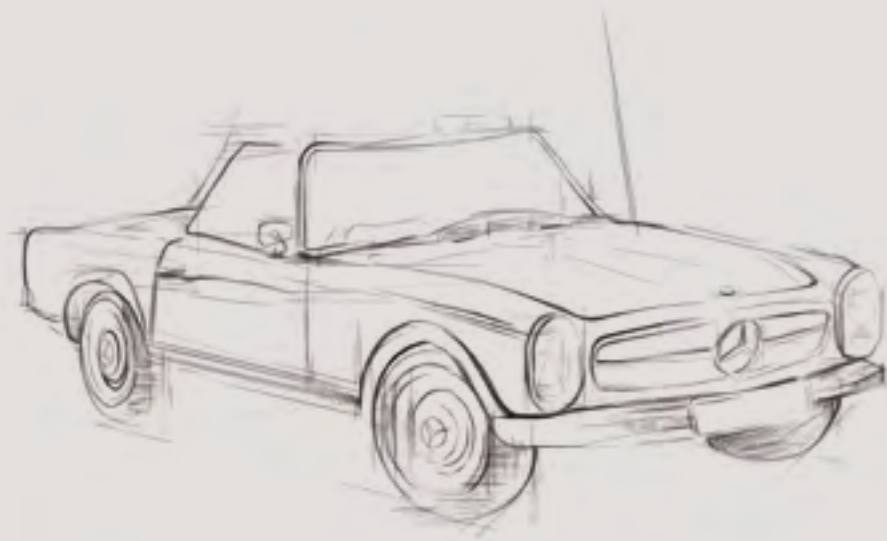

Contemplating products from BOS1964 is like looking at a Mercedes. Prestige, highest quality and long-lasting. An office from BOS1964 is, by its finishes and quality, contemporary and a guarantee of the highest level.

*Contemplar los productos de BOS1964 es como contemplar un Mercedes. Prestigio, calidad y perdurabilidad en el tiempo. Un despacho de BOS1964 por sus acabados y calidad siempre es actual y hablar de BOS1964 es hablar de máximo nivel.*

## Expertise Pericia

Belongs to a limited circle of office furniture manufacturers where product perfection is a core value and a continuous search. Therefore and since its founding, BOS1964 controls all production processes: from purchase and selection of the best natural wood veneers and cow hides to pre-assembly and distribution. We care a lot about our finishes and all our wood veneers are worked by hand and the end product is assigned a unique serial number, which makes tracking easy and guarantees a personalized after sales service. This is part of our total client satisfaction focus.

*BOS1964 pertenece a un reducido círculo de fabricantes muebles que, fiel a sus valores, busca la perfección de sus productos. Por ello, y desde que se fundó la firma, BOS1964 controla todos los procesos de producción: desde la compra y selección directa de las mejores maderas y pieles hasta su montaje previo y distribución. Con un cuidado estricto de los acabados, todas las maderas se trabajan a mano y el producto final siempre lleva un número de serie para hacer un seguimiento del mismo y ofrecer un servicio de posventa personalizado que garantice la total satisfacción de nuestros clientes.*



UNE-EN ISO  
9001:2015

UNE-EN ISO  
14001:2015

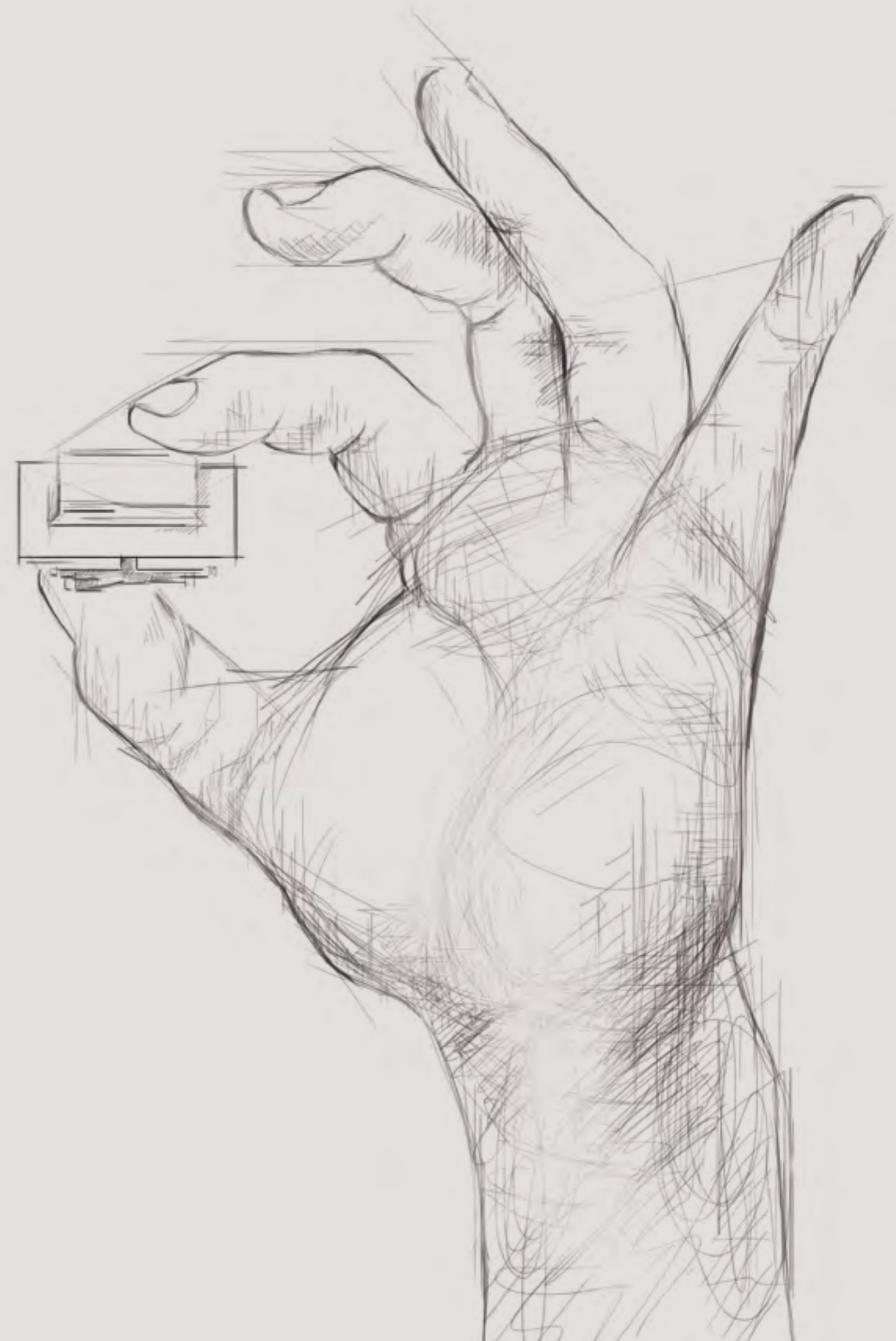

## Designers Diseñadores

One of our main objectives is to find a perfect balance between classic and modern designs that ensures durability as well as icons in terms of handcraft and innovation. This is achieved thanks to our dynamic multicultural team which, by combining top-notch technology and strong expertise in traditional manufacturing, is able to provide unique and exclusive solutions to meet the needs of our most demanding clients. Our ambition to maintain leadership in executive office furniture drives us to continually innovate in providing highly resilient furniture of supreme quality.

*Uno de los principales objetivos es encontrar el equilibrio perfecto entre el clasicismo y la modernidad para que nuestros productos perduren con el paso del tiempo y se conviertan en un icono de artesanía e innovación. Esto se consigue gracias a un equipo dinámico y multicultural que, combinando la tecnología de última generación con los conocimientos de la manufactura tradicional, puede seguir ofreciendo soluciones exclusivas y únicas a la altura de las necesidades más exigentes. Nuestra ambición por ser un referente en mesas de despacho, mesas de reuniones y sillas de dirección es lo que nos inspira para seguir innovando y ofrecer muebles con una durabilidad y calidad suprema.*



### Sørig

Is born in Denmark and develops his professional activity as "Industrial designer". Starts his studies at "Kunstakademiets Arkitektkskole" and at the "Aarhus school of architecture" building his own business in 1995 "Sorig Designstudio". Works for different sectors and known brands such as Bang&Olufsen and Swarovski, gaining different prices such as IF Cebit Award 1995, Las Vegas Best of show, 2000.

*Nace en Dinamarca y desarrolla su actividad profesional como "diseñador industrial". Empieza su formación en "Kunstakademiets Arkitektkskole" y en la "Aarhus school of architecture" montando su propio estudio en 1995 "Sorig Designstudio". Trabaja para distintos sectores destacadas y marcas como Bang&Olufsen y Swarovski, cosechando diversos premios como IF Cebit Award 1995, Las Vegas Best of show, 2000.*



### Arola

Born in Tarragona in 1960 and starts his professional career at the studio "Lievore y Pensi" and later at "AD Associate Designers". He starts his own studio in 1994 "Estudio Arola" In parallel with his business he also gives classes at the university. Has won several prices Silver Delta Price, 1999 and 2001, National design price, 2003, Price I Plus, 2009, Reddot award, 2012 and is honorable member of the design organization APPI.

*Nace en Tarragona en 1960 e inicia su carrera profesional en el estudio "Lievore y Pensi" y posteriormente en "AD Associate Designers" fundando su propio estudio en 1994 "Estudio Arola". Compagina su carrera profesional con la docencia y ha cosechado diversos premios. Premio Delta de plata 1999 y 2001, Premios nacional de diseño en 2003, Premio I Plus 2009, Red Dot Award 2012 y nombrado "soci d' honor APPI".*



### Pensi

Leaves his natal country Argentina in 1975 and establishes himself in Barcelona in 1984 and creates "Jorge Pensi Design Studio". Jorge Pensi has given conferences and workshops all around the world. He and his designs have received several prizes among which is the Spanish design price in 1997.

*Deja su país de origen Argentina en 1975, se establece en Barcelona en 1984 y crea su propio studio "Jorge Pensi Design Studio" Jorge Pensi ha dictado conferencias, seminarios y workshops en distintos lugares del mundo. Él y sus productos han cosechado diversos premios, entre ellos el premio nacional de diseño en 1997 en España.*



### Danesi

Is an Italian designer born in Bolzano in 1948. Starts his career at the architect studio "Baniera e Facchini" and concentrates his activity mainly in Office furniture projects. He starts his own business in 1980 as product designer and art director as well as consultant for international companies in the office sector.

*Es un diseñador Italiano nacido en Bolzano en 1948. Empieza su carrera profesional en el estudio de los arquitectos "Bandiera e Facchini" y centra su actividad primordialmente en los proyectos de sistemas de oficina. Funda su propio estudio en 1980 como product designer, art director y asesor para empresas del sector de oficinas, italianas y extranjeras.*



### BOS Barcelona Design Team

BOS Barcelona Design Team is made up of designers and Project developers with accumulated experience far beyond their own, as they continue a design tradition that dates back to 1939. This is the BOS1964 design cradle from which accumulated knowledge has made possible the products that BOS1964 offers today.

*BOS Barcelona Design Team es un equipo de diseñadores y proyectistas que ostentan una dilatada experiencia muy superior a la de su propia existencia como continuadores de grandes equipos de diseño del pasado existentes desde 1939 de cuya enseñanza se han beneficiado consiguiendo los productos que BOS1964 ofrece en la actualidad.*

## International *Internacional*

An international focus has always been a top priority for BOS1964, with a long track record of more than 30 years exporting to more than 40 countries worldwide, continuously growing in our effort to reach new markets.

*La vocación internacional siempre ha sido la máxima a seguir de los responsables de BOS1964; con una experiencia dilatada en este ámbito, en la actualidad BOS1964 tiene incidencia en más de 40 países y continúa trabajando incesantemente para abrir nuevos mercados.*

Dubai  
*Dubai*

Cairo  
*El Cairo*

Brussels  
*Bruselas*

Doha  
*Doha*

Bahrain  
*Baréin*

Kuwait  
*Kuwait*

Muscat  
*Mascát*

Moscow  
*Moscú*

St. Petersburg  
*St. Petersburgo*

Warsaw  
*Varsovia*

Barcelona  
*Barcelona*

Lisbon  
*Lisboa*

Astana  
*Astaná*

Geneva  
*Ginebra*

Almaty  
*Almaty*

Sofia  
*Sofía*

Athens  
*Atenas*

Luxemburg  
*Luxemburgo*



Touring  
16

01

Diktat  
32

02

Titanium  
90

05

Oxford  
106

06

BCN  
48

03

Chairs  
*Sillas*  
116

07

Bookcases  
*Librerías*  
124

08

Sixty  
76

04

Technology  
*Tecnología*  
132

09





A

S

T

B L

E

BOS1964  
18 - 19

Tables  
Mesas

Touring  
Diktat  
Bcn

Sixty  
Titanium  
Oxford

Our most presidential collection  
*Nuestra colección más presidencial*

Design / Diseño:  
Danesi

# Touring

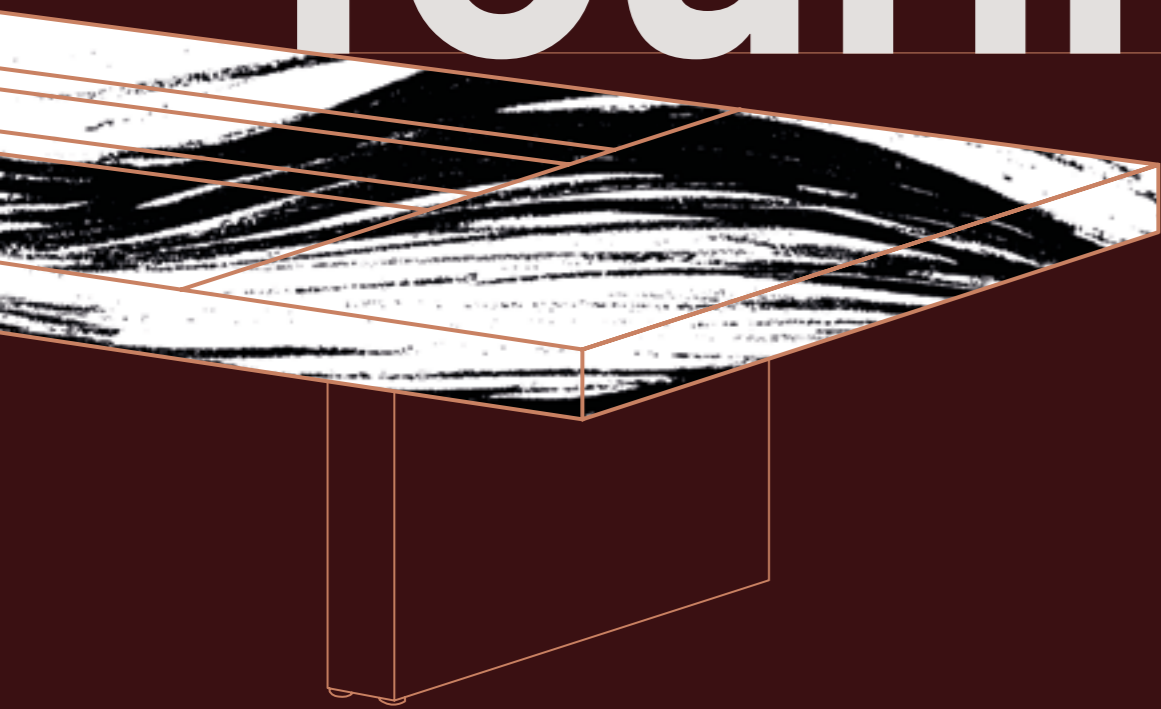

BOS  
1964  
BARCELONA





Ebony makassar wood  
RAL 8023 piano lacquer  
5600x1800





RAL 7039 matt lacquer  
Leather Fusion 912  
RAL 7024 matt lacquer  
4200x1400



American Walnut wood high gloss  
Leather Fusion 925  
RAL 8017 piano lacquer  
9800x2000  
h 750/950



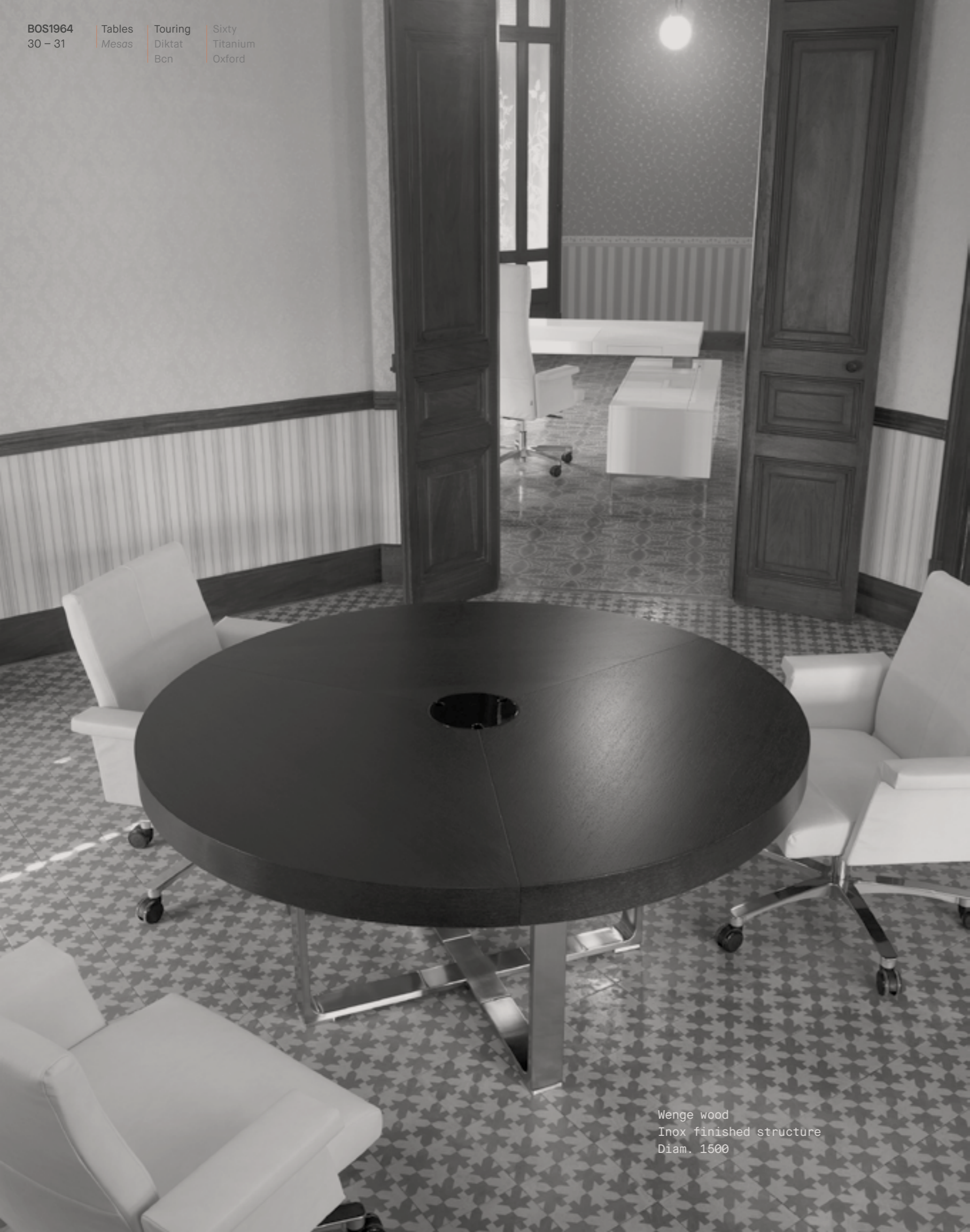

Wenge wood  
Inox finished structure  
Diam. 1500



Intercontinental Hotel  
Egypt



American walnut wood  
Black piano lacquer  
2800x1400



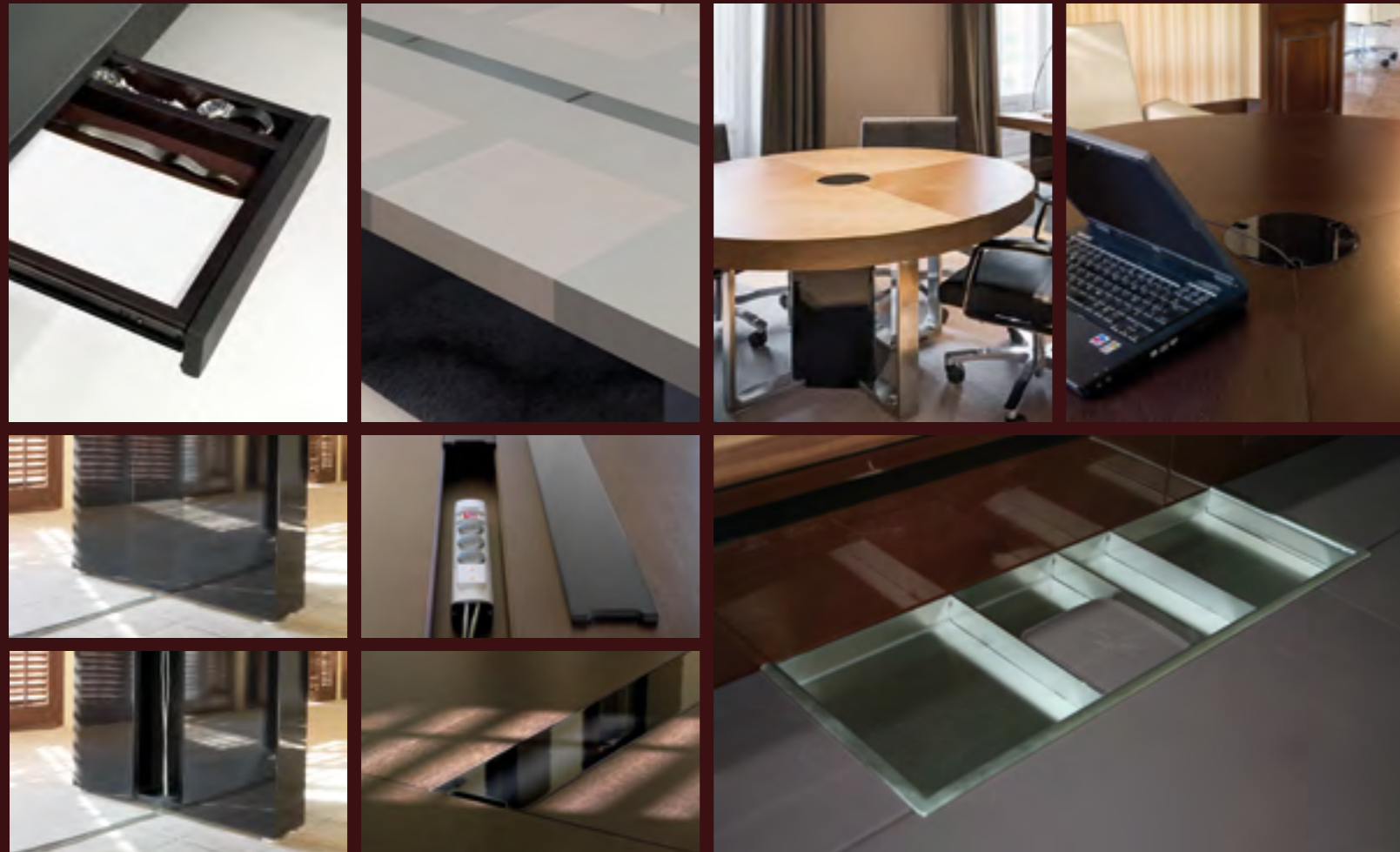

**TECHNICAL INFORMATION**  
*INFORMACIÓN TÉCNICA*

**Table top**  
*Sobre*

**Thickness**  
*Grosor*



85

**Shape**  
*Forma*

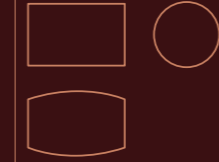

**Finishes**  
*Acabados*

Wood / *Madera*  
Lacquer / *Lacado*  
Leather / *Piel*

**Structure**  
*Estructura*

**Shapes**  
*Formas*



140

**Finishes**  
*Acabados*

Wood / *Madera*  
Lacquer / *Lacado*

**Dimensions in mm and capacity**  
*Dimensiones en mm y capacidad*

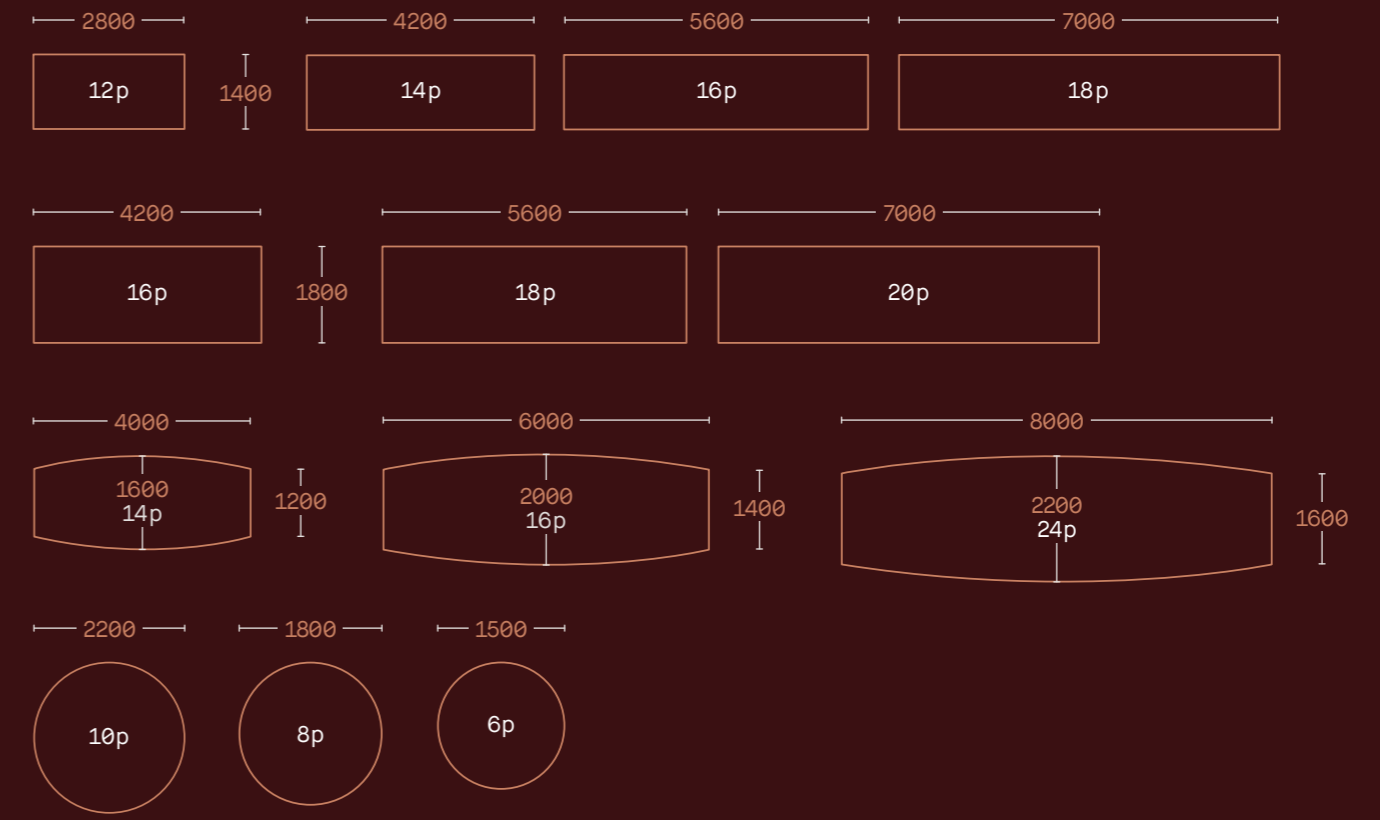

Chairs  
*Sillas*

C

H

A



R



S

Musa



Lauro



Dea



Vela



Lina



Lauro



Musa



Dea



Vela



Dina



Aranda



**Musa**

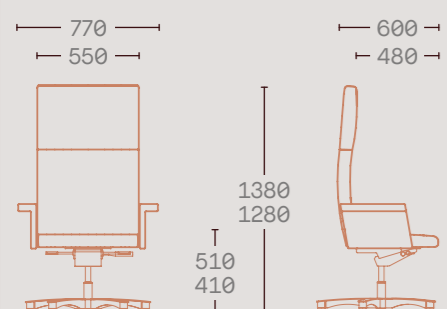
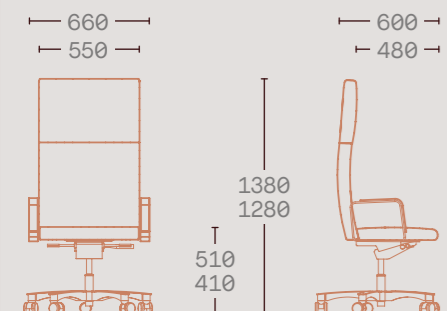
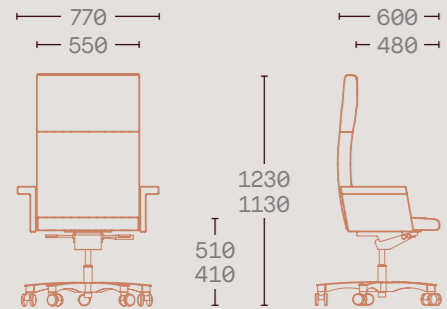
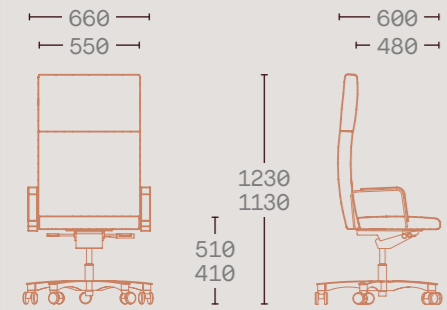
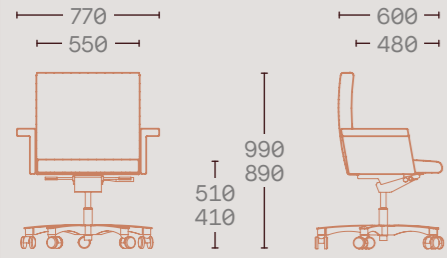
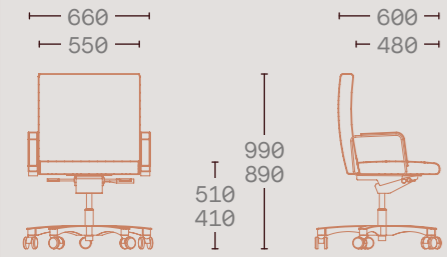

**Lauro**

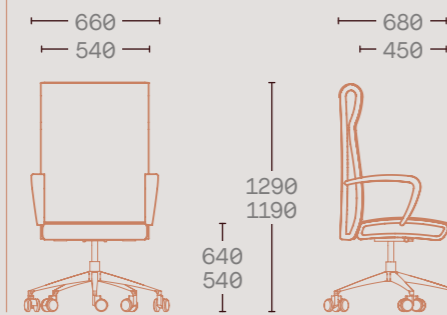
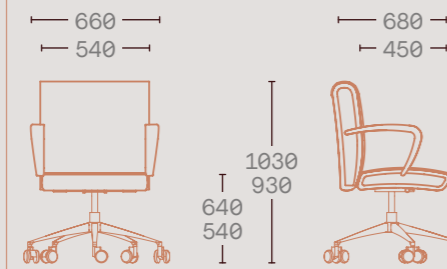
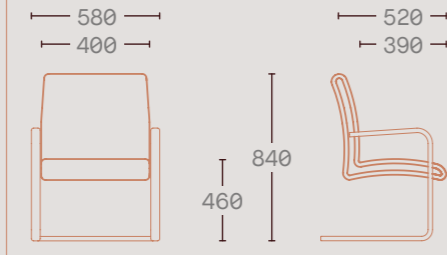

**Dea**

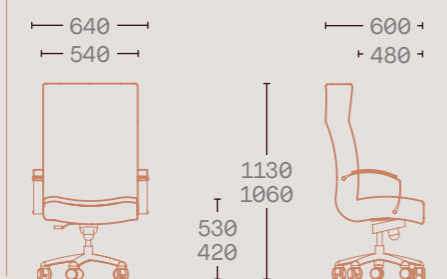
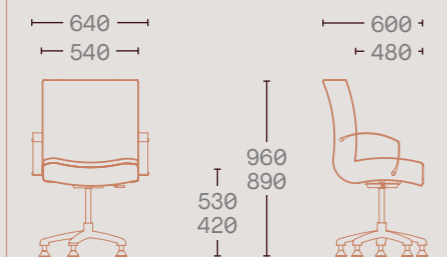
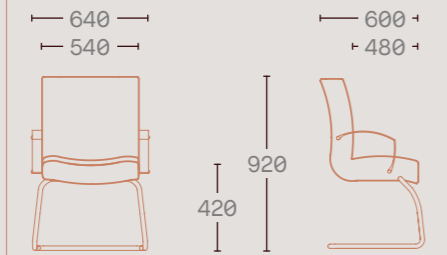

**Aranda**

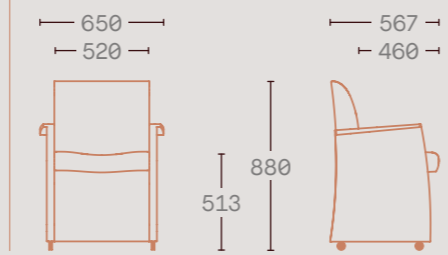

**Lina**

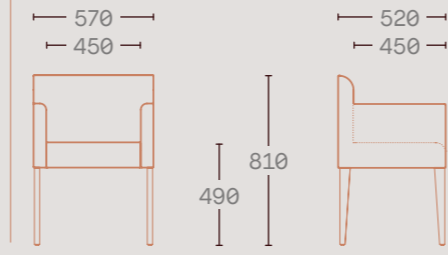

**Dina**

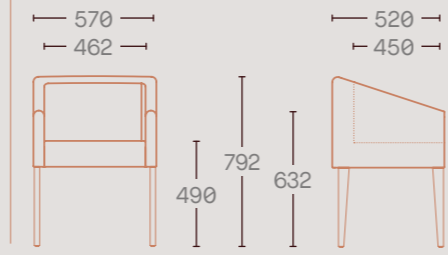

**Vela**

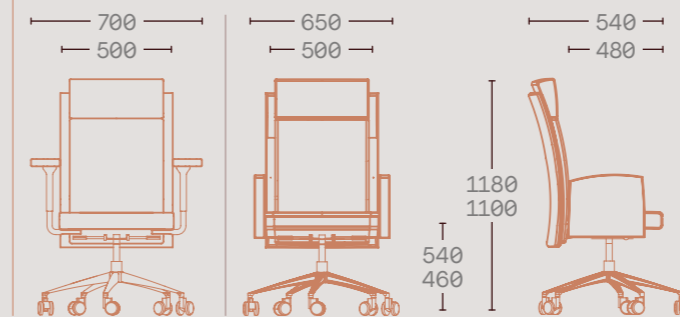
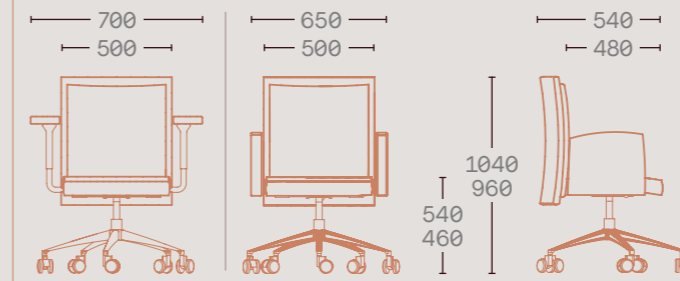
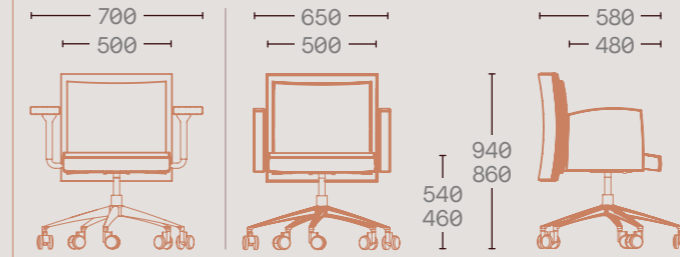
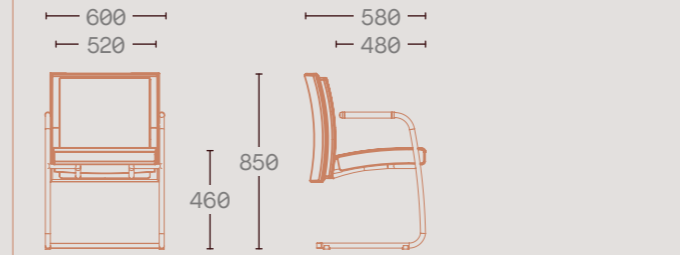

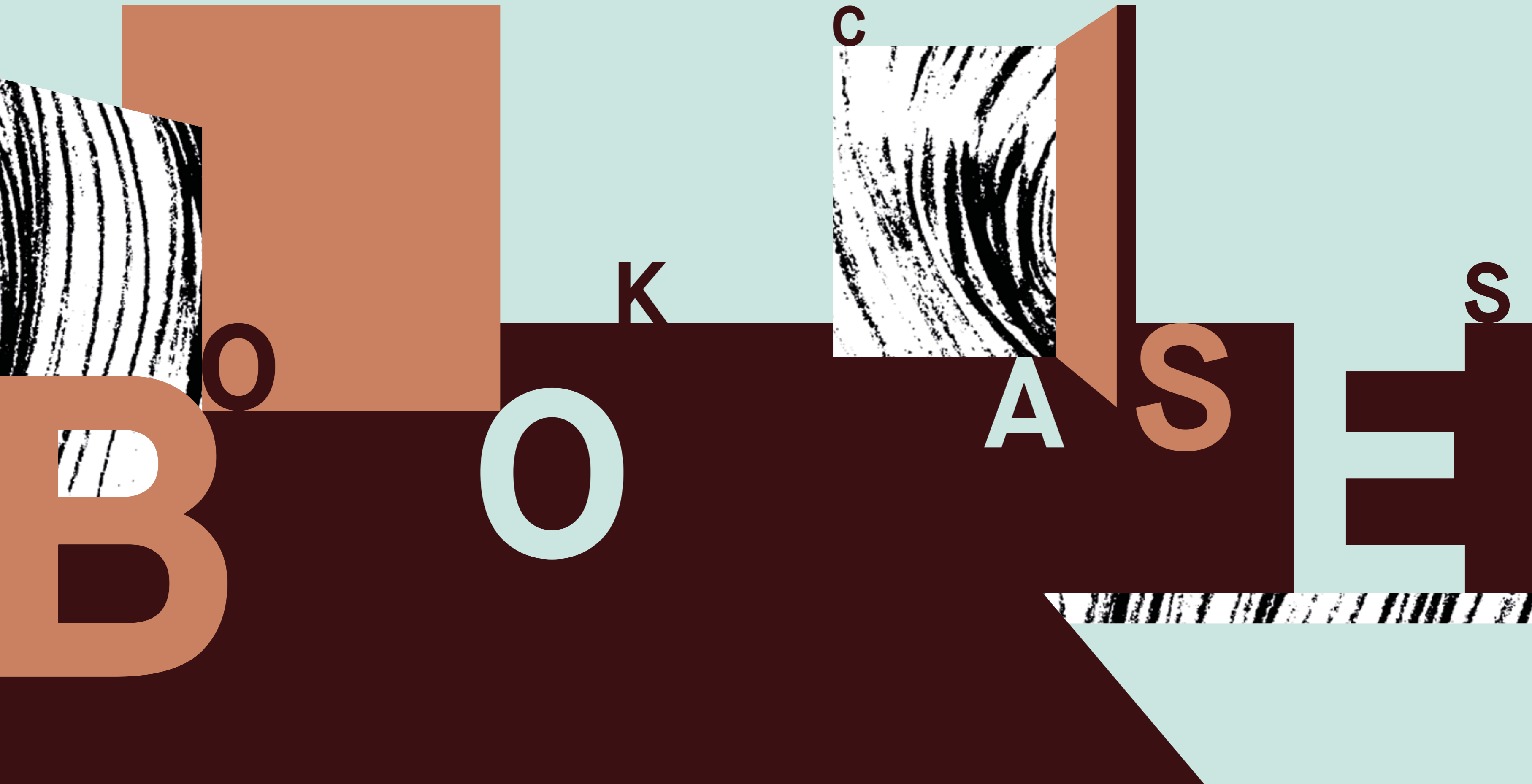

Luxury bookcases  
*Librerías 'Luxury'*

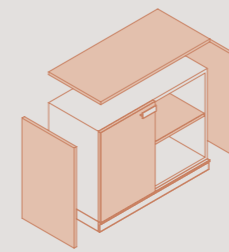

● Wood/Madera  
○ Lacquered/Lacado



1840x460  
h 736



2290x460  
h 736



2740x460  
h 736



1840x460  
h 1376



2740x460  
h 1376



2290x460  
h 2016



2740x460  
h 2016

Recommended with: Touring, Diktat, BCN and Sixty  
Recomendaciones junto a: Touring, Diktat, BCN y Sixty



CUSTOMIZED WALL UNIT WITH MIRROR TV  
MUEBLE A MEDIDA CON ESPEJO CON TELEVISOR INTEGRADO

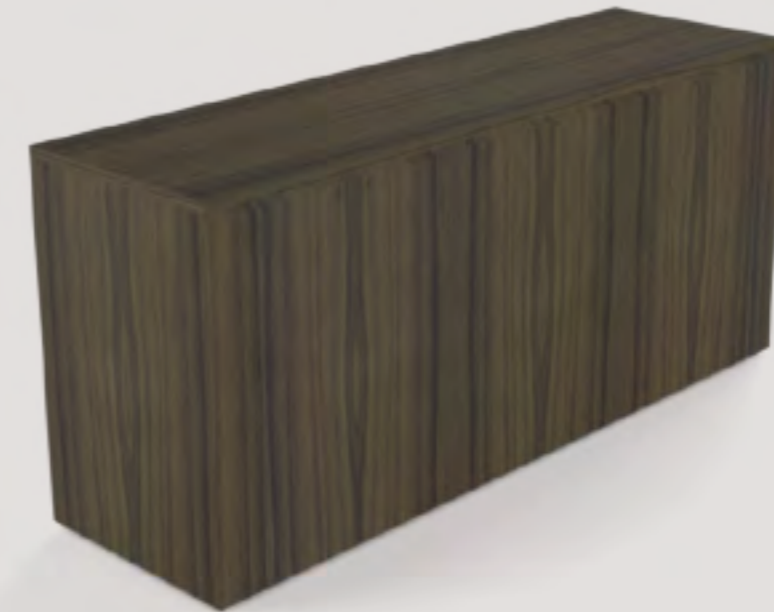

CUSTOMIZED SIDEBORD WITH INBUILT SCREEN. MAX. SCREEN SIZE 65"  
MUEBLE A MEDIDA CON TELEVISOR INCORPORADO. DIMENSIÓN MÁX. PANTALLA 65"





### Premium bookcases *Librerías 'Premium'*

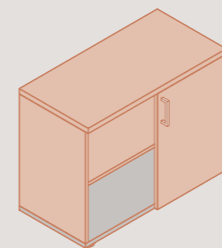

- Wood/Madera
- Laminated/Melamina

1800x450  
h 700



2700x450  
h 700



900x450  
h 1340



900x450  
h 1980



2700x450  
h 1340



1800x450  
h 1980



2700x450  
h 1980

### Standard bookcases *Librerías 'Standard'*

Melamine options in black or white color  
*Opción de melamina en color negro o blanco*

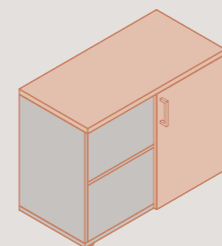

- Wood/Madera
- Laminated/Melamina

2700x450  
h 700



2700x450  
h 1980



1800x450  
h 1980



900x450  
h 1340



2700x450  
h 700



2700x450  
h 1980



1800x450  
h 1980

Recommended with: Oxford and Titanium  
*Recomendaciones junto a: Oxford y Titanium*

TECHNOLOGY

Power units



PU1  
3/6 positions  
Lacquer



PU4  
2 positions  
Matt chromed  
Inox

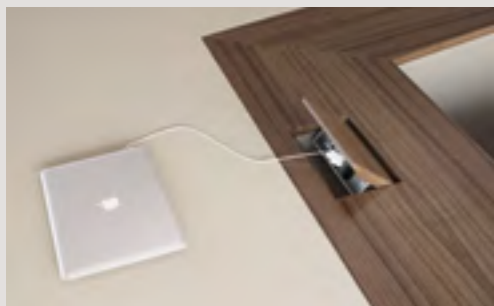

PU2  
3/6 positions  
Wood



PU5  
3/6 positions  
RAL 9006 (aluminium)  
RAL 7016 (anthracite)  
Chromed  
Inox  
RAL 9005 (black)  
RAL 9010 (white)



PU3  
4/8 positions  
RAL 9006 (aluminium)  
RAL 9005 (black)



PU6  
4/8 positions  
RAL 9006 (aluminium)  
RAL 9005 (black)



Power strips



HDMI  
HDMI



RJ45 cat6  
RJ45 cat6



USB  
USB



DVI



HDMI  
USB



HDMI



XLR  
3 pins



RCA



HDMI  
RJ45 cat6



USB  
RJ45 cat6



RJ45 cat6



Schuko



UK socket  
45°

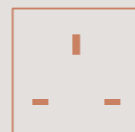

UK socket



USB



VGA  
with jack

Options for power strip positions  
Opciones para posiciones de la regleta

Cable outlets



CO1  
Inox

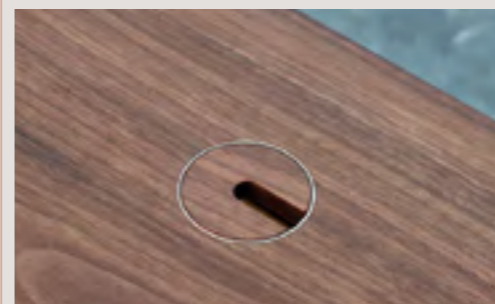

CO2  
Wood



CO3  
RAL 9006 (aluminium)  
RAL 9010 (white)  
RAL 9005 (black)

Elevation



E1



Vertical canalization

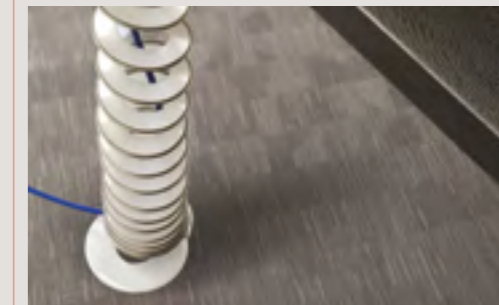

VC1



VC2



VC3

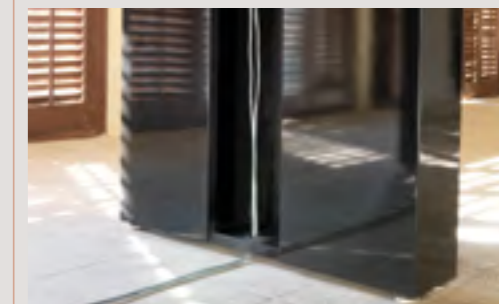

VC4



Flap



F1



F2



F3



F4



F5

Vertical elevation



VE1



VE2



VE3



VE4



VE5

Accessories



A1



A2



A3

Screen sizes: 12" to 22"  
Dimensiones pantallas: 12" a 22"

## Finishes *Acabados*

BOS1964 only works with the absolute highest quality of finishes in wood as well as in upholstery with brands such as Kvadrat, Gabriel, Curtidos Gracia and Camira.

Next, you will find a selection of the available finishes which we work with. To know the whole collection, please visit the following site:

[www.bos1964.com](http://www.bos1964.com)

*BOS1964 utiliza en sus productos los mejores materiales en acabados de madera y en marcas de tapicería como Kvadrat, Gabriel, Curtidos Gracia y Camira.*

*A continuación, os presentamos una selección de nuestros acabados. Para conocer el catálogo entero visiten la siguiente dirección:*

[www.bos1964.com](http://www.bos1964.com)

**Natural wood**  
*Madera natural*

The natural wood comes standard with matt finish but is also available with high gloss finish.

*De serie, la madera natural tiene un acabado mate; pero también está disponible en alto brillo.*

**Lacquer & paint**  
*Laca & pintura*

These RAL colors are available for lacquer when applied on MDF and for paint when applied on metal parts. The lacquered colors are available with matt or piano lacquer finish (different RAL colors can be used upon request).

*Los colores RAL, cuando son aplicados en madera son lacas y cuando son aplicados en superficies metálicas, son pinturas. Las lacas, están disponibles en mate o laca piano. Bajo petición, se puede aplicar cualquier color.*

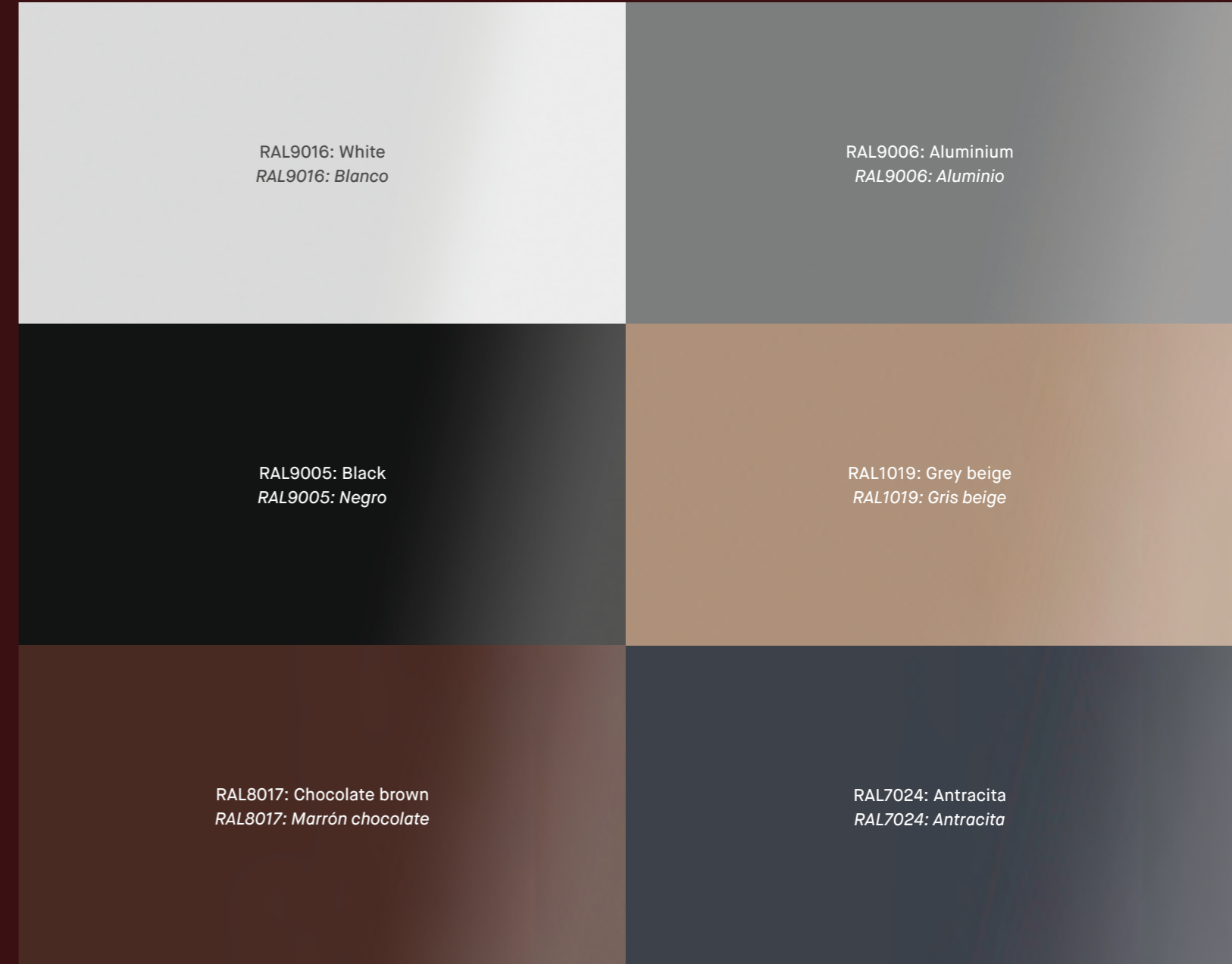
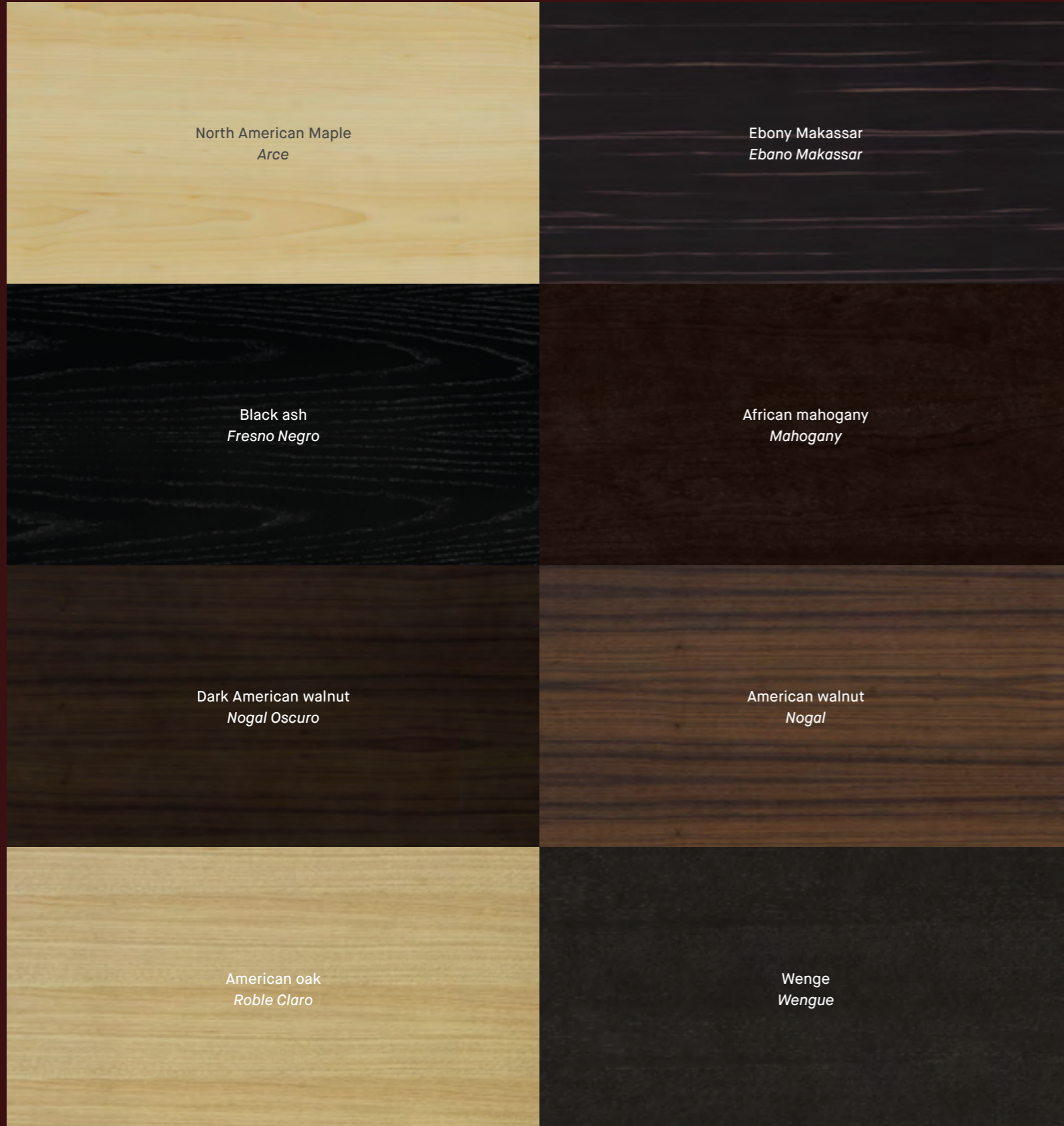

Serie 900 Fusion by Curtidos Gracia  
*Serie 900 Fusion de Curtidos Gracia*



Blazer collection by Camira  
*Colección Blazer de Camira*



Main Line Flax collection by Camira  
*Colección Main Line Flax de Camira*



# Thanks for trusting us

## *Gracias por confiar en nosotros*

### EUROPE

Barcelona airport  
Allianz  
Bank of london  
Bayer  
Danone  
Fitch ratings  
Gestamp  
Good-year  
Hospital de barcelona  
Kone  
Procter & gamble  
Renault  
Repsol  
University de barcelona  
Kempinski hotels  
Mclaren mercedes benz  
Henkel  
Mitsubishi  
Banco santander  
Ing real estate  
Heineken  
Icbc  
Rolex  
France telecom  
Porsche  
Bnp  
Bbl

### CIS COUNTRIES

Compass  
Kazchrome  
Visor  
Vtb bank  
Marie claire  
Sap  
Boeing  
Teva  
Mondelez  
Fti  
Moscow mayor office  
Apostol  
Egvikinot  
Total

### MIDDLE EAST

Arab news channel  
Gulf corporation for technology  
K.O.C (kuwait oil company)  
Nizwa bank  
Mohsin haider darwish  
The land  
King saud university  
Sama (saudi arabian monetary agency)  
Sec (sceco)  
Qassim university  
Qatargas  
Qatar foundation  
Abu dhabi sports council  
Crown prince court  
Dubai airport  
First gulf bank  
Global investment group in fortune tower dubai  
Magnificent media dubai  
National bank of abu dhabi  
Royal jet

### AFRICA

African bank  
Barclays  
Carlyle  
Cib bank  
Limitless  
Mantrac  
Noor  
Hsbc  
Imperial investment  
Municipality of cabinda  
Intercontinental  
Rama