



## Sound absorbing panel with central hole

A round, sound-insulating panel with a hole in the middle that gives it its tasty name. Tasty by name and tasteful by nature: a sleek round form with a space in the middle for lighting, to be covered with one of the specially designed 3D prints available in all the colours of the BuzziSpace spectrum. The BuzziDonut is a fine piece that does not just light up the room but improves the acoustic qualities of the space as well.

Design by BuzziSpace Studio

---

## General

-  BuzziDonut | BuzziDonut Stack  
Pattern: Flat, 3D Rib, 3D Drop, 3D Leaf  
Fixing: Wall | Pendant

Core: Honeycomb cardboard + MDF  
Filling: Acoustic foam

-  Cover: Fabric, Rough, Trevira CS+ | CS, Revive 1, Revive 2, Terra, Clara 2, Remix 2, Hero, Tonus 4, Memory 2, Matrix  
Back: Antiskid (black with white BuzziSpace logo)

-  S: Ø 80 cm x 6 cm  
Ø 31.50" x 2.36"
- M: Ø 100 cm x 6 cm  
Ø 39.37" x 2.36"
- L: Ø 120 cm x 6 cm  
Ø 47.24" x 2.36"

-  S: Antiskid backing: 3.5 kg | 7.72 lbs  
Fabric backing: 4 kg | 8.82 lbs
- M: Antiskid backing: 4.5 kg | 9.92 lbs  
Fabric backing: 6 kg | 13.23 lbs
- L: Antiskid backing: 5.5 kg | 12.13 lbs  
Fabric backing: 8 kg | 17.64 lbs

- ... Fixation: wall mounted | ceiling pendant: Fixing System Screw or Fixing System Magnet  
Black or Alu cables 2 - 5 m | 78.74" - 196.85"

---

## Acoustics



Absorption



Diffusion



Mid tone



High tone

---

## Content

Configurations	3	Fixing Systems	11
Patterns	5	Dimensions	13
Fabrics	7	Acoustics	15

---

# Configurations

## BuzziDonut Wall



S, M, L



Cover: Fabric, Rough, Trevira CS+ | CS, Revive 1, Revive 2, Terra, Clara 2, Remix 2, Hero, Tonus 4, Memory 2, Matrix



S: Ø 80 cm x 6 cm  
Ø 31.50" x 2.36"

M: Ø 100 cm x 6 cm  
Ø 39.37" x 2.36"

L: Ø 120 cm x 6 cm  
Ø 47.24" x 2.36"



S: Antiskid backing: 3.5 kg | 7.72 lbs

Fabric backing: 4 kg | 8.82 lbs

M: Antiskid backing: 4.5 kg | 9.92 lbs

Fabric backing: 6 kg | 13.23 lbs

L: Antiskid backing: 5.5 kg | 12.13 lbs

Fabric backing: 8 kg | 17.64 lbs

\*\*\* Fixation: wall mounted

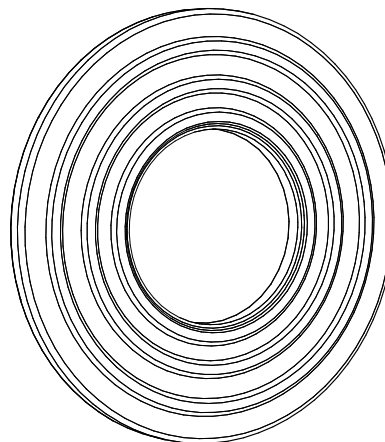

## BuzziDonut Pendant

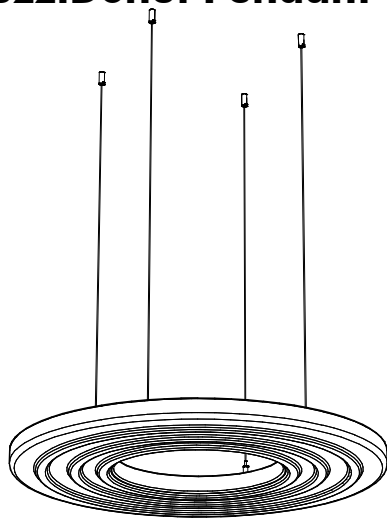

S, M, L



Cover: Fabric, Rough, Trevira CS+ | CS, Revive 1, Revive 2, Terra, Clara 2, Remix 2, Hero, Tonus 4, Memory 2, Matrix



S: Ø 80 cm x 6 cm  
Ø 31.50" x 2.36"

M: Ø 100 cm x 6 cm  
Ø 39.37" x 2.36"

L: Ø 120 cm x 6 cm  
Ø 47.24" x 2.36"



S: Antiskid backing: 3.5 kg | 7.72 lbs

Fabric backing: 4 kg | 8.82 lbs

M: Antiskid backing: 4.5 kg | 9.92 lbs

Fabric backing: 6 kg | 13.23 lbs

L: Antiskid backing: 5.5 kg | 12.13 lbs

Fabric backing: 8 kg | 17.64 lbs



Fixation: wall mounted | ceiling pendant: Fixing System

Screw or Fixing System Magnet

Black or Alu cables 2 - 5 m | 78.74" - 196.85"



If installing on suspended ceiling, verify load capacity prior to installation.

---

## BuzziDonut Stack

🔑 S, M, L

🌲 Cover: Fabric, Rough, Trevira CS+ | CS, Revive 1, Revive 2, Terra, Clara 2, Remix 2, Hero, Tonus 4, Memory 2, Matrix

S: Ø 80 cm x 6 cm  
Ø 31.50" x 2.36"

✂ M: Ø 100 cm x 6 cm  
Ø 39.37" x 2.36"

L: Ø 120 cm x 6 cm  
Ø 47.24" x 2.36"

S: 3,5 kg Antiskid | 4 kg Fabric Backing  
7.71 lbs Antiskid | 7.80 lbs Fabric Backing

⚖ M: 4,5 kg Antiskid | 6 kg Fabric Backing  
9.92 lbs Antiskid | 13.22 lbs Fabric Backing

L: 5,5 kg Antiskid | 8 kg Fabric Backing  
12.12 lbs Antiskid | 17.63 lbs Fabric Backing

⋮ Fixation: Ceiling pendant: Fixing System Screw Fixing System

Black or Alu cables 2 - 5 m | 78.74" - 196.85"

⚠ If installing on suspended ceiling, verify load capacity prior to installation.

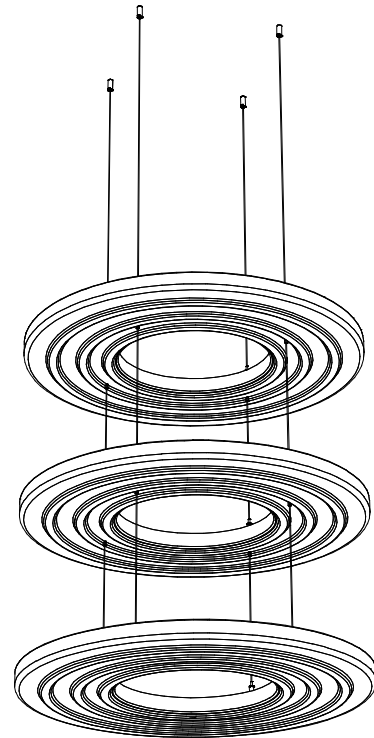

# Patterns

---

## Flat

L

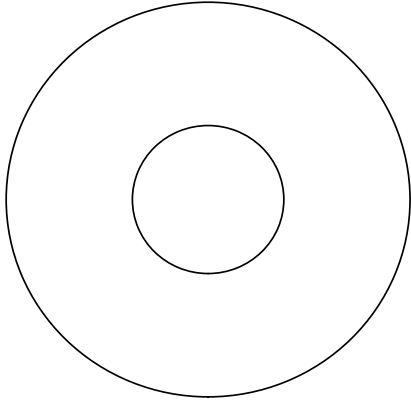

M

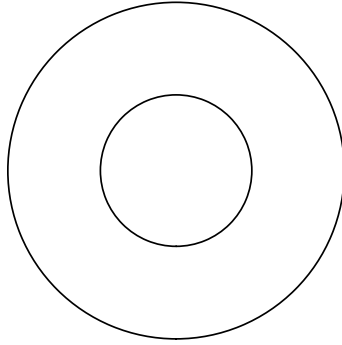

S

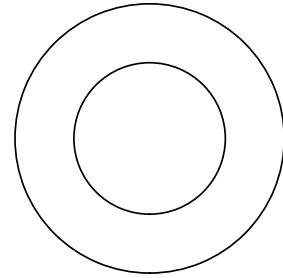

---

## 3D Rib

L

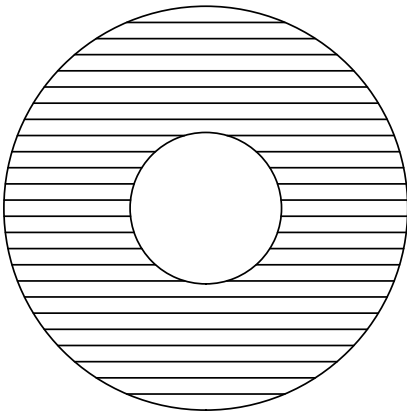

M

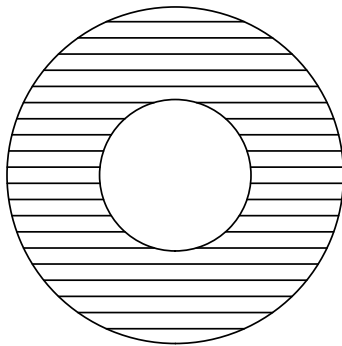

S

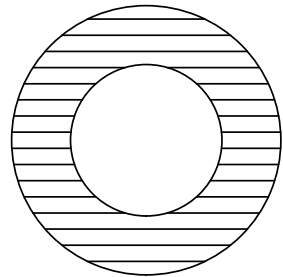

---

### 3D Leaf

L

M

S

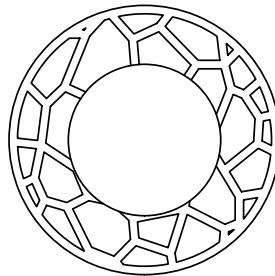
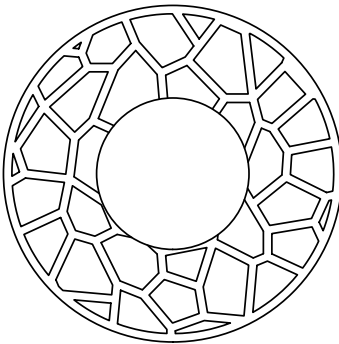
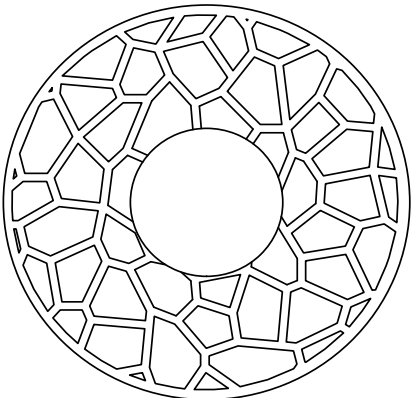

---

### 3D Drop

L

M

S

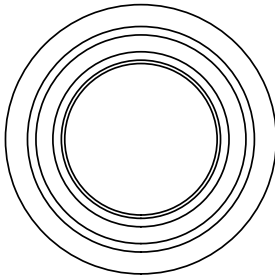
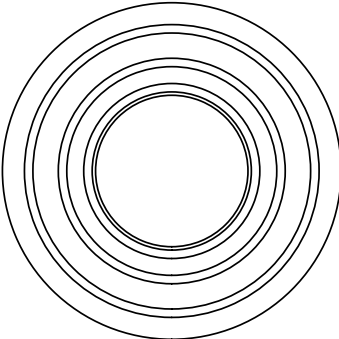
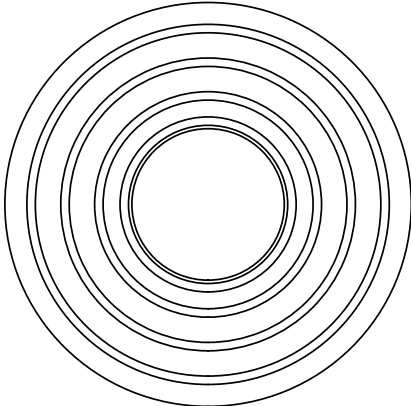

# Fabrics

---

## Fabric

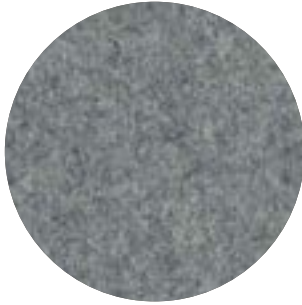

**Category A**

**Composition** 70% Recycled Wool, 25% Recycled Polyacryl,  
5% Recycled Other Fabrics

**Weight** 405 g/m<sup>2</sup> | 11.94 oz/yd<sup>2</sup>

**Abrasion resistance** 40.000 Martindale, 50,000 Wyzenbeek

**Flammability** EU: EN 1021.1/2006 | BS EN 1021.1/2006 (cigarette).  
EN 1021.2/2006 | BS EN 1021.2/2006 (match)  
USA: CAL TB 117 | ASTM E84 CLASS A

**Fastness to light** EU 4 | USA 4

**Fastness to rubbing** EU: Wet 3-4 | Dry 4-5

**Fastness to crocking** USA: Wet 5 | Dry 5



## Rough

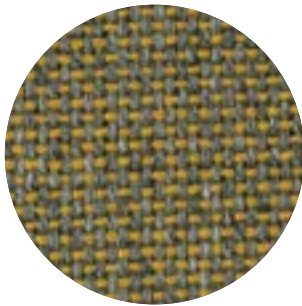

**Category A**

**Composition** 100% Polyacryl

**Weight** 456 g/m<sup>2</sup> | 13.45 oz/yd<sup>2</sup>

**Abrasion resistance** 40.000 Martindale

**Flammability** EU: EN 1021.1/2006 | BS EN 1021.1/2006 (cigarette)

**Fastness to light** EU: 5

**Fastness to rubbing** EU: Wet: 3 | Dry: 3



## Trevira CS+ | CS

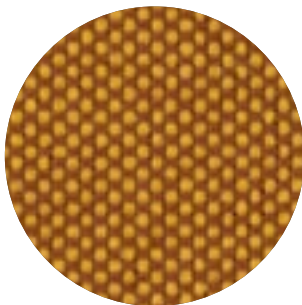

**Category A**

**Weight** 420 g/m<sup>2</sup> | 12.39 oz/yd<sup>2</sup>

**Composition** 100% Polyester, Trevira CS

**Abrasion resistance** 100.000 Martindale, 90,000 Wyzenbeek

**Flammability** BS 5852 part II: CRIB 5 | BS 7176 Medium Hazard  
USA: CAL TB 117 | M1 | B1 | EN 1021/1-2 | C1 |  
EN 1021/1-2  
IMO Res. A652 (16)

**Fastness to light** EU: 6 | USA 5

**Fastness to rubbing** EU: Wet 4-5 | Dry 4-5

**Fastness to crocking** USA: Wet 5 | Dry 5



## Revive 1

kvadrat



**Category A**

**Composition** 100% recycled polyester FR

**Weight** 430 g/lin.m

**Abrasion resistance** 60.000 Martindale rubs, EN ISO 12947

**Flammability** EN 1021-1/2 | DIN 4102 B1 | Önorm B1/Q1  
UNI 9175 11M | US Cal. Tech. Bull. 117  
IMO A.652 (16)

**Fastness to light** Note 5-7, ISO 105-B02

**Fastness to rubbing** (ISO) dry 5, wet 4-5

**Pilling** Note 4-5, EN ISO 12945



## Revive 2

kvadrat

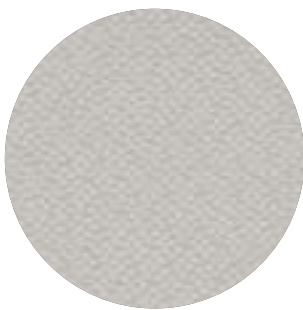

**Category A**

**Composition** 100% recycled polyester FR

**Weight** 420 g/lin.m

**Abrasion resistance** 45.000 Martindale rubs, EN ISO 12947

**Flammability** EN 1021-1/2 | DIN 4102 B1 | Önorm B1/Q1  
UNI 9175 11M | US Cal. Tech. Bull. 117  
IMO A.652 (16)

**Fastness to light** Note 5-7, ISO 105-B02

**Fastness to rubbing** (ISO) dry 5, wet 4-5

**Pilling** Note 4-5, EN ISO 12945



## Terra



**Category B**

**Composition** 100% Pure New Wool

**Weight** 370 g/m<sup>2</sup> | 10.91 oz/yd<sup>2</sup>

**Abrasion resistance** 40.000 Martindale, 25,000 Wyzenbeek

**Flammability** EU: BS5852 CRIB 5 | BS5867 PART 2 : 2008 : TYPE B  
EN 1021.2/2006 | USA: CAL TB 117

**Fastness to light** EU 5 | USA 5

**Fastness to rubbing** EU: Wet 4 | Dry 4

**Fastness to crocking** USA: Wet 4 | Dry 4



## Clara 2

kvadrat

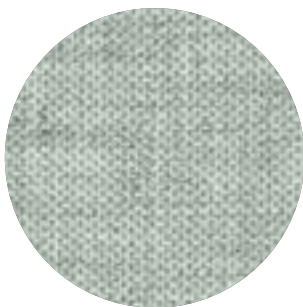

**Category B**

**Composition** 92% new wool, 8% nylon

**Weight** 400 g/lin.m

**Abrasion resistance** 80.000 Martindale rubs, EN ISO 12947

**Flammability** EN 1021-1/2 | BS 5852, ignition source 2-3 | DIN 4102 B2  
NF D 60 013 | UNI 9175 11M | US Cal. Tech. Bull. 117, Sec. E  
NFPA 260 | IMO A.652(16)

**Fastness to light** Note 5-7, ISO 105-B02

**Fastness to rubbing** (ISO) dry 4-5, wet 4

**Pilling** Note 4, EN ISO 12945





## Remix 2

kvadrat



**Category B**

**Composition** 90% new wool, 10% nylon

**Weight** 415 g/lin.m

**Abrasion resistance** 100.000 Martindale rubs, EN ISO 12947

**Flammability** EN 1021-1/2 | BS 5852 part 1

Önorm B1/Q1 | NF D 60 013 | UNI 9175, 1IM

AS/NZS 1530.3 | Cal. Tech. Bull. 117-2013

NFPA 260 | IMO FTP Code 2010:Part 8

**Fastness to light** Note 5-7, ISO 105-B02

**Fastness to rubbing** (ISO) dry 4-5, wet 4

**Pilling** Note 4, EN ISO 12945



## Hero

kvadrat

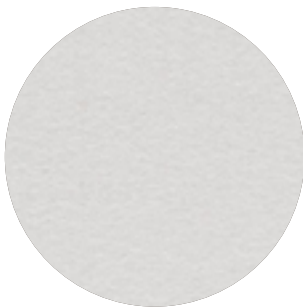

**Category C**

**Composition** 96% new wool, 4% nylon

**Weight** 580 g/lin.m

**Abrasion resistance** 45.000 Martindale rubs, EN ISO 12947

**Flammability** EN 1021-1/2 | DIN 4102 B2 | NF D 60 013

UNI 9175 1IM | US Cal. Bull. 117-2013 | NFPA 260

IMO A.652 (16)

**Fastness to light** Note 5-6, ISO 105-B02

**Fastness to rubbing** (ISO) dry 4-5, wet 4-5

**Pilling** Note 3-4, EN ISO 12945



## Tonus 4

kvadrat



**Category D**

**Composition** 90% new wool, 10% Helanca

**Weight** 665 g/lin.m

**Abrasion resistance** 100.000 Martindale rubs, EN ISO 12947

**Flammability** EN 1021-1/2 | BS 5852 part 1 | DIN 4102 B2

Önorm B1/Q1 | NF D 60 013 | UNI 9175 1IM

US Cal. Bull. 117-2013 | NFPA 260 | IMO A.652 (16)

**Fastness to light** Note 5-7, ISO 105-B02

**Fastness to rubbing** (ISO) dry 3-5, wet 3-5

**Pilling** Note 3, EN ISO 12945



---

## Memory 2

kvadrat



**Category** E

**Composition** 100% Trevira CS

**Weight** 700 g/lin.m

**Abrasion resistance**

35.000 rubs acc. to the Martindale method, EN ISO 12947

**Flammability** EN 1021-1/2 | DIN 4102 B1 | Önorm B1/Q1

NF D 60 013 | NF P 92 507 M1 | UNI 9175 11M

UNI 9177 classe 1 | US Cal. Tech. Bull. 117

IMO A.652 (16)

**Fastness to light** Note 5-8, ISO 105-B02

**Fastness to rubbing** (ISO) dry 4-5, wet 4-5

**Pilling** Note 4, EN ISO 12945



---

## Antiskid (back only)



# Fixing Systems

---

## Fixing System Wall (optional)

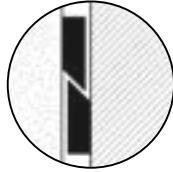
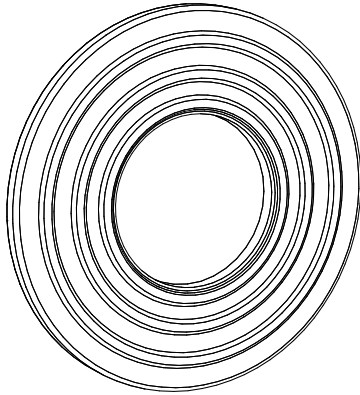

- Screws for wall not included.
- One metal wall mount.
- Three adjuster glides

---

## Fixing System Ceiling Suspended (optional)

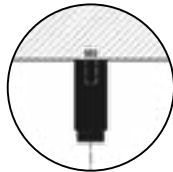
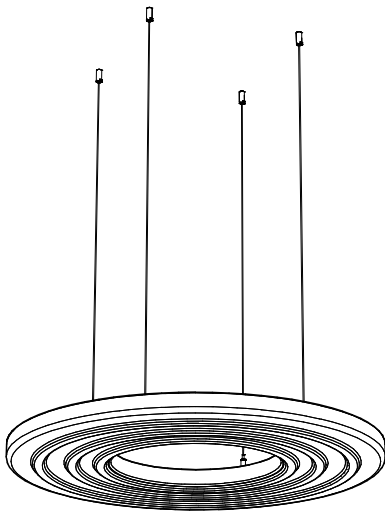

### Fixing System Screw

- 4 cables of 2 - 5 m | 78.74" - 196.85"
- Black or aluminium colored cables

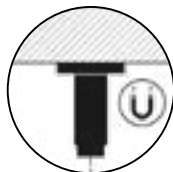
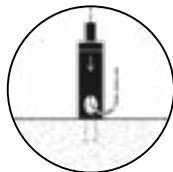

### Fixing System Magnet

- 4 cables of 2 - 5 m | 78.74" - 196.85"  
Black or aluminium colored cables  
(not recommended with Donut Stack)

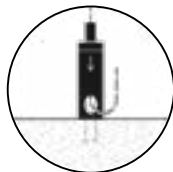

\*\*1 magnet (Ø 3,2 cm H 0,8 cm | Ø 1.26" H 0.31") can take up to 10 kg | 22.05 lbs when hanging on a solid metal surface.

---

---

# Donut Stack

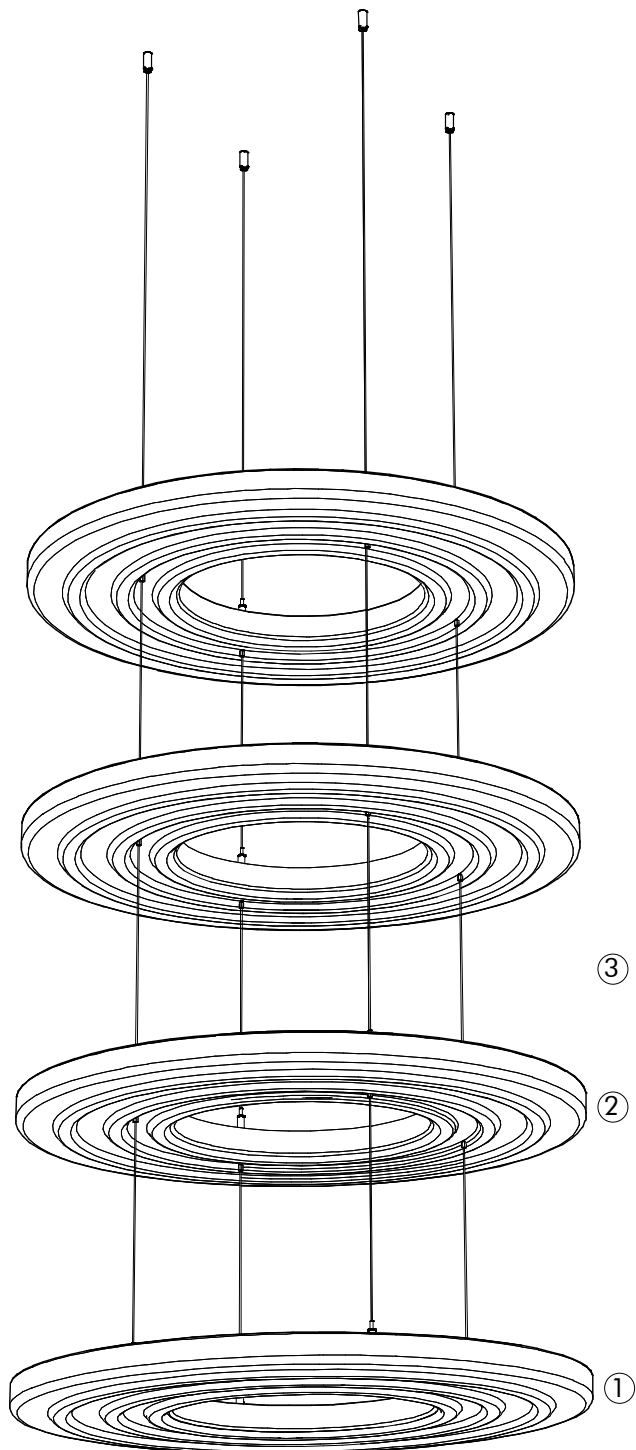

## 1. Bottom ring is always BuzziDonut

Only one Fixing System is needed  
Screws for ceiling not included, 2 stair bolts M6 needed.

## 2. Every ring above is always BuzziDonut Stack

Maximum 4 levels: BuzziDonut + 3 BuzziDonut Stacks

## 3. Distance between Donuts

Because the wires run trough each element without interruption, you can modify and adjust at all times. Each ring is packed separately.

- Install cables (supplied with Donut pendant)
  - Slide over all Donut Stacks one by one
  - End chain with normal Donut
-

# Dimensions

## Donut

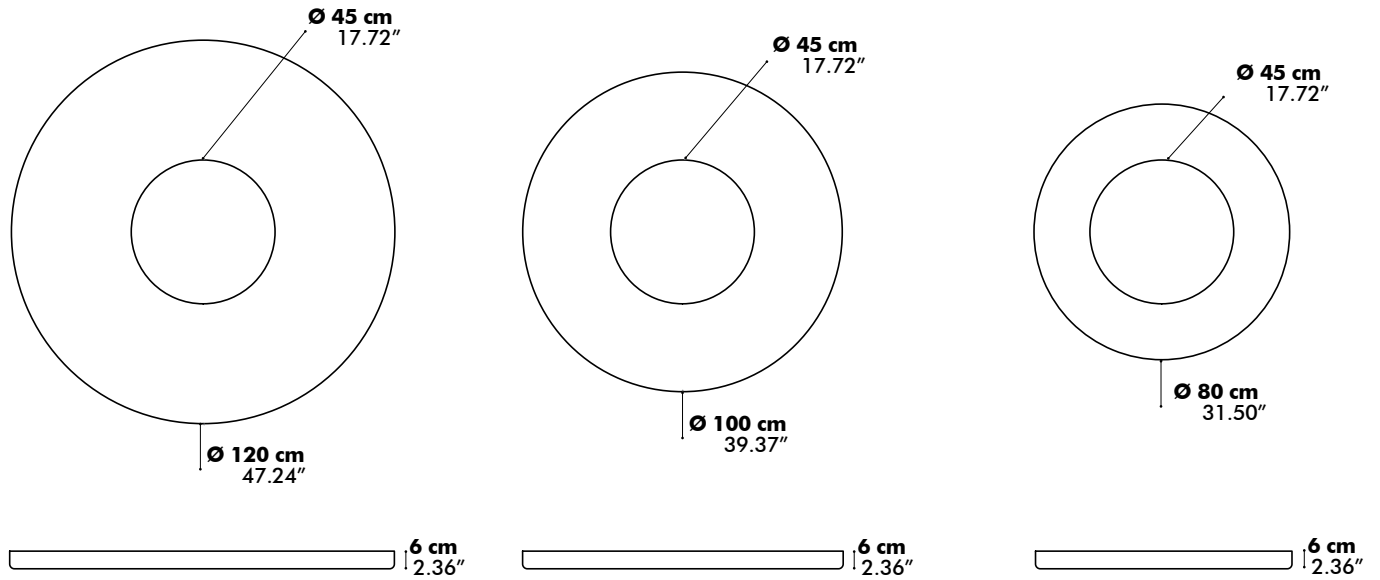

## Wall Fixing System

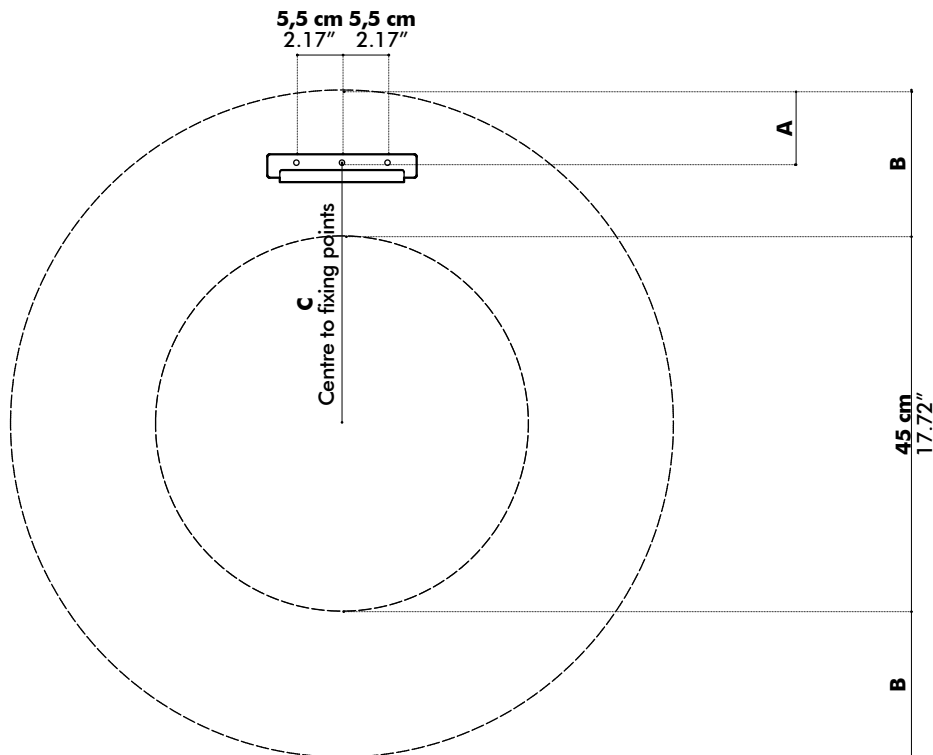

	A	B	C
S	11,5 cm - 4.53"	17,5 cm - 6.89"	28,5 cm - 11.22"
M	21,5 cm - 8.46"	27,5 cm - 10.83"	28,5 cm - 11.22"
L	31,5 cm - 12.40"	37,5 cm - 14.76"	28,5 cm - 11.22"

# Donut fixing points

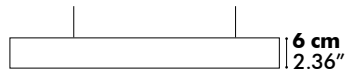
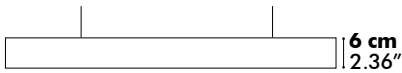
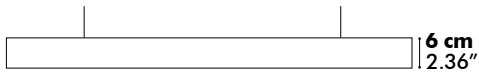
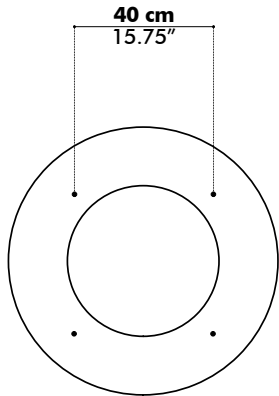
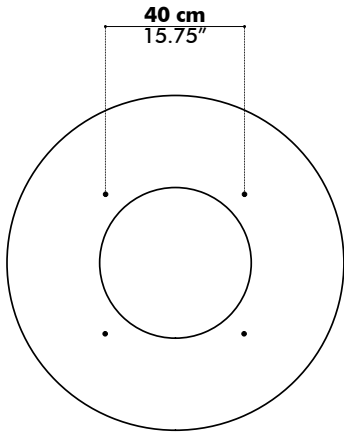
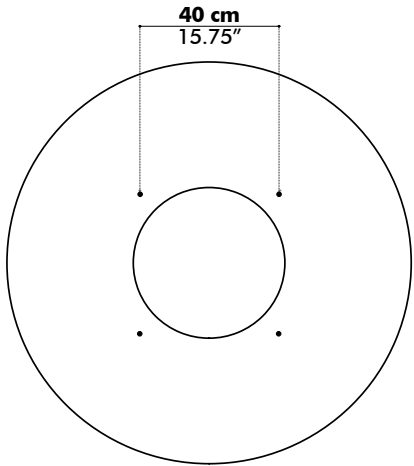

# Acoustics

## BuzziDonut

Equivalent sound absorption area in m<sup>2</sup> per object

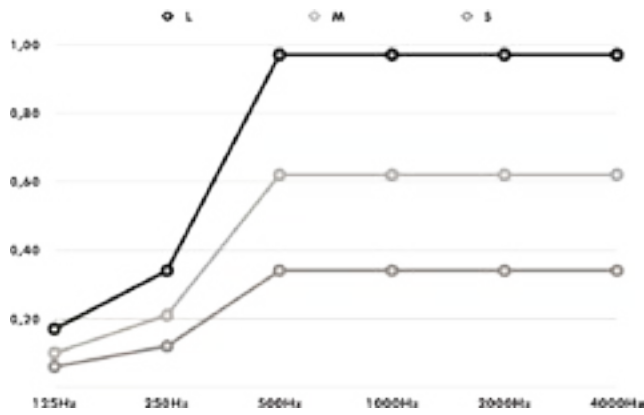

Hz	L Aeq/m <sup>2</sup>	M Aeq/m <sup>2</sup>	S Aeq/m <sup>2</sup>
125	0.17	0.10	0.06
250	0.34	0.21	0.12
500	0.97	0.62	0.34
1000	0.97	0.62	0.34
2000	0.97	0.62	0.34
4000	0.97	0.62	0.34